

*Interactive 3D graphic, click to activate and rotate.
(3D capable PDF viewer required)*

Your Caster, Wheel & Material Handling Solutions Provider

Caster Central is the leading caster and wheel provider for all your mobility and handling needs. With over 150 years in business, we understand the need for reliable mobility solutions. No matter the application, we have high-quality solution for your company's use.

Thanks to our devoted team, we have provided clients with top-quality caster solutions for years. Our customers receive the best solutions for their needs and suitable recommendations from skilled professionals.

Technical Details	
Part No.	AS40P1TPUSB
Series	A-Line Series
Fastening Type	Top Plate Swivel
Fastening Size	2.5" x 3.622" (P1)
Wheel Diameter [INCH]	4
Tread Width [INCH]	1 1/4
Wheel Type	Thermo-Urethane (TPU)
Capacity [lbs.]	275
Mount Height [INCH]	5 1/4
Bearing Type	Precision Ball
Brake Type	Side Tread Lock (SB)
Swivel Radius [INCH]	3 3/4
Thread Guard	Full

Standard Features

- The industry's most popular 1-1/4" wide caster sizes, wheels, fastenings, brakes, and accessories
- Thick, high-strength steel construction
- Dual ball bearing raceway design
- Raceway dust cap standard on all swivel models for increased caster life and performance
- Dynamic load capacities up to 350 lbs. per caster
- Durable zinc finish
- 3/8" diameter nut and bolt axle
- Full thread guards and precision ball bearings on TPR and TPU wheels provide performance and help prevent debris from entangling wheel

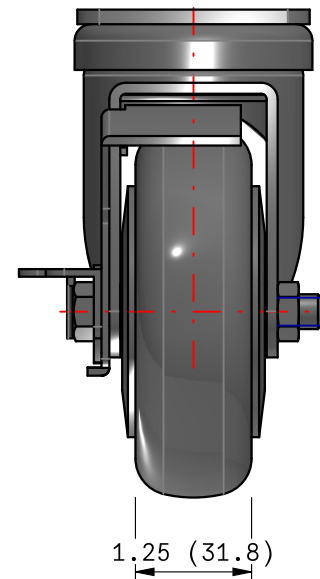
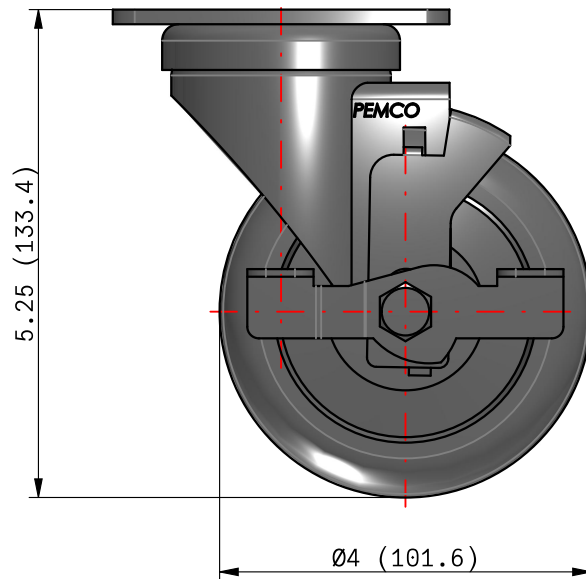
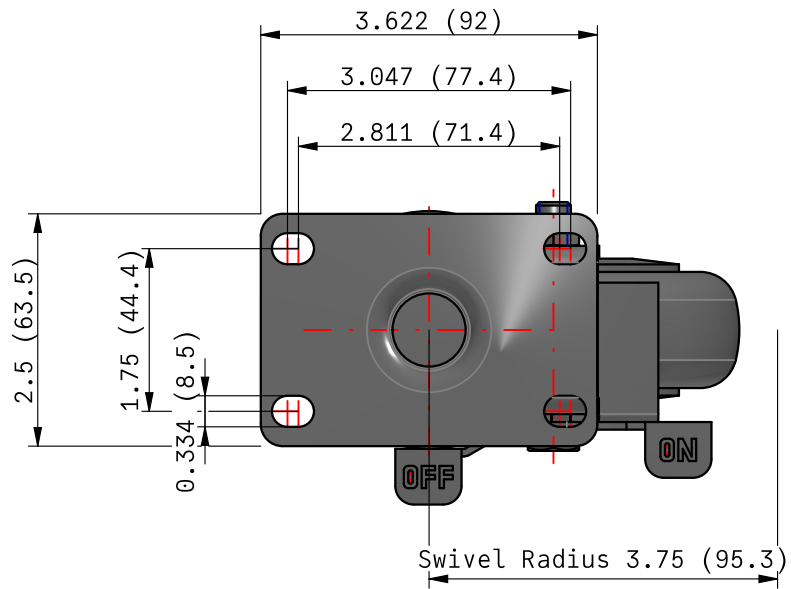

Part Number:

AS40P1TPUSB

Series:

A-Line

Brand:

W.T. Hight

Caster Central

div. of W.T. Hight Company
 42 Winter Street, Suite 18
 Pembroke, MA 02359
 800-445-4082
www.castercentral.com
www.wthight.com