

Ameriflex® Diaphragm Couplings

High Speed, High Performance Design

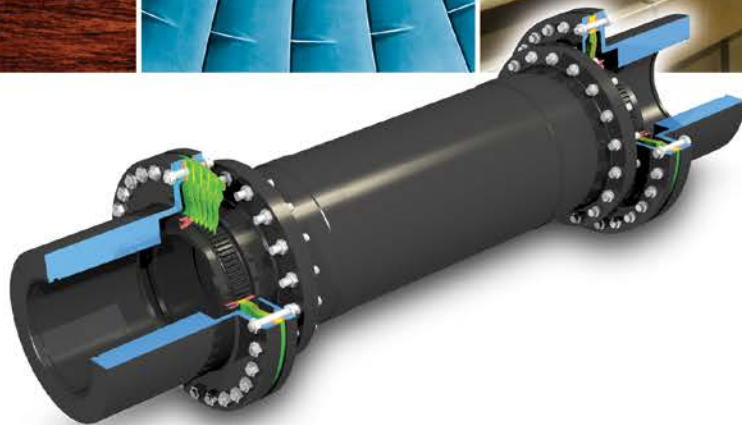

Diaphragm Couplings

Since its introduction in 1971, the Ameriflex multiple convoluted diaphragm coupling has continued to set new standards for life and reliability in high performance machinery applications. Today, by using the latest design and manufacturing technology, Ameridrives is able to offer increased diaphragm coupling performance without compromising this outstanding reliability.

Advanced analysis and manufacturing processes have produced increased ratings without reducing safety factors. The use of the latest finite element analysis methods verified by strain gage and dynamic testing has allowed for a more precise calculation of the Ameriflex diaphragm stresses.

Using state-of-the-art manufacturing processes, we have developed our new INTEGRAL FILLER diaphragm pack. The INTEGRAL FILLER diaphragm allows for greater design flexibility. The number and thickness of diaphragms and the diaphragm stress distribution are optimized while maintaining the traditional benefits of thin, separated, multiple convoluted diaphragms. Combining and optimizing the ratio of the steady state and dynamic stresses of the diaphragm allows for increased continuous torque capacity while maintaining infinite

life design. In addition, the Ameriflex coupling is now provided with 15-5 PH stainless steel as standard diaphragm material. This is the same material used in our most critical military marine propulsion and aircraft applications.

These technologies allow for increased versatility in Ameriflex coupling design. Users may now choose the coupling best suited for their application. Direct interchangeability is maintained with previously supplied Ameriflex couplings.

The INTEGRAL FILLER diaphragms permit increased torque capacity without compromising Ameridrives' standard conservative design practices. Safety factors are consistent and are not changed based on

service or application factor, such as those specified by API-671. Ameriflex Couplings have infinite life at catalog ratings without the use of a minimum application factor.

The design of the Ameriflex coupling enables the user to reliably compensate for the increased demands of high performance turbomachinery. The inherent low axial and bending stiffness of the multiple convoluted diaphragm reduces bearing loads, which can increase equipment life.

Ameridrives is committed to customer satisfaction. Let our team provide a flexible coupling for your important application.

Table of Contents	Page
Ameriflex Advantages	3
Series Description.....	4
Coupling Designation, Construction and Materials	5
Multiple Convoluted Diaphragm Pack	6-7
Coupling Selection.....	8-9
Ameriflex RR Series (Reduced Ratio)	
Engineering Data	10
Ratings.....	11
Ameriflex RM Series (Reduced Ratio)	
Engineering Data	12
Ratings.....	13
Ameriflex RS Series (Reduced Ratio Short)	
Engineering Data	14
Ratings.....	15
Ameriflex HP Series (High Performance)	
Engineering Data	16
Balance	18
Speed Limits, Axial Natural Frequency (ANF)	18
Retrofitting.....	19
Ameriflex Variations and Custom Applications.....	20-21
Coupling Selection Requirements	22-23



The Ameriflex Advantage

- High torque to diameter ratio
- High torque to weight ratio
- Low windage and horsepower loss
- Diaphragms designed for infinite life using Finite Element Analysis verified by strain gage and dynamic testing
- R Series integral filler diaphragm maintains diaphragm flex area separation with optimized convolution form
- All Ameriflex couplings are manufactured to API-671 requirements
- Low bending moment and axial force while maintaining high torque capacity, resulting in lower bearing loads
- Symmetrical diaphragm does not subject connected equipment to an alternating moment
- Large axial travel capability with constant axial stiffness
- Low repeatable unbalance
- Multiple separated diaphragms in a pack provide a built-in, fail-safe feature
- Diaphragms are 15-5 PH stainless steel
- Shot-peened diaphragms for improved fatigue strength and stress corrosion resistance
- Diaphragms capable of operating in extreme environments without protective coatings
- Black oxidized, heat treated, alloy steel torque transmitting components are standard
- Sub-assemblies are field replaceable
- Maintenance free for years of dependable performance
- Customized designs available

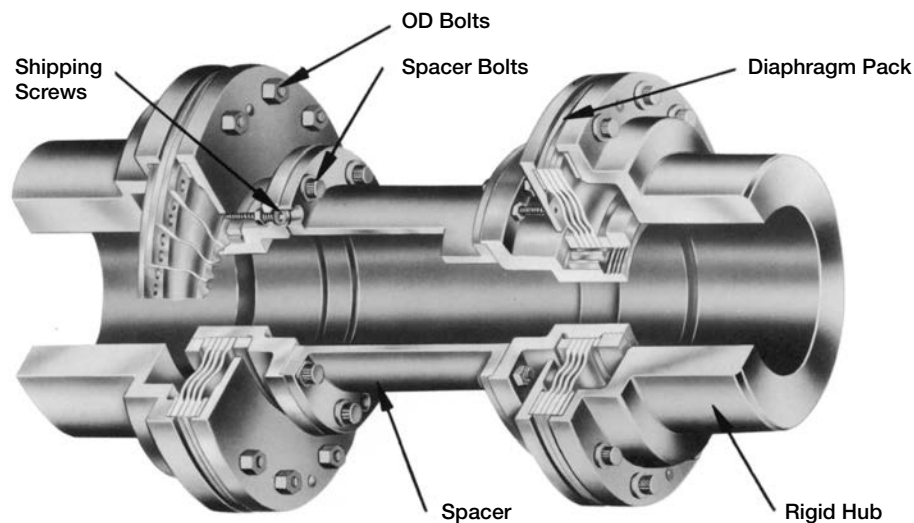

AMERIFLEX RR SERIES COUPLING

Fig. 1

Diaphragm Couplings

Series Description

RR Series (Reduced Ratio)

The Reduced Ratio design (Figure 2) offers high torque and large bore capacity, with a light weight, low moment assembly. Large axial travel capacity is maintained. Torque is transmitted from the pack to the spline adapter by a major diameter interference fit spline. The inside diameter of the pack is tightly clamped by a high strength clamp nut.

RM Series (Reduced Moment)

The reduced Moment design (Figure 3) provides a large bore and high torque capacity with the lowest overhung moment. Large axial travel capacity is maintained. Torque is transmitted from the hub to pack by a major diameter interference fit spline. The inside diameter of the pack is tightly clamped by a high strength clamp nut. Locking helicoils in the guards are now a standard feature, which further reduces windage and horsepower loss.

RS Series (Reduced Ratio Short)

The Reduced Ratio Short design (Figure 4) maintains the high torque to bore ratio and the large axial travel capacity of the RR Series with a one piece center section. Most commonly used for short shaft-to-shaft applications and gear coupling retrofits with high torsional stiffness. Torque is transmitted from the pack to the center shaft by a major diameter interference fit spline. The inside diameter of the pack is tightly clamped by a high strength clamp nut. Locking helicoils in the guards are now a standard feature.

HP Series (High Performance)

The original High Performance design (Figure 5) is used where very large axial travel capacity and the lowest stiffnesses are desired. The pack transmits torque to the spline adapter through a major diameter interference fit spline. The inside diameter of the pack is tightly clamped by the clamp ring bolts.

In accordance with our established policy to constantly improve our products, the specifications contained herein are subject to change without notice.

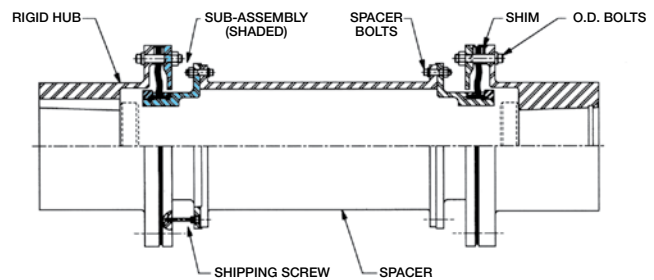

Fig. 2

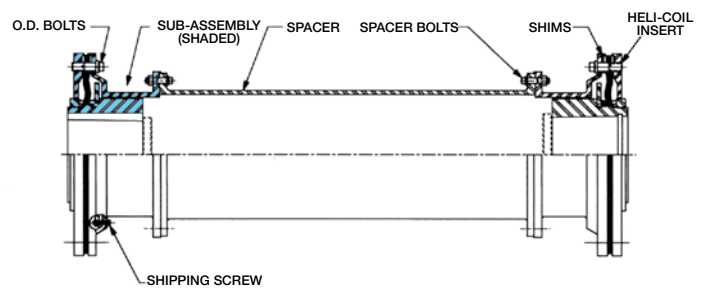

Fig. 3

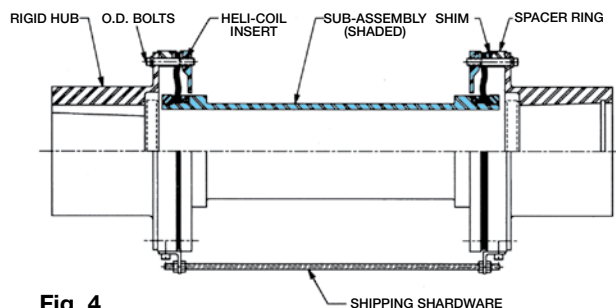

Fig. 4

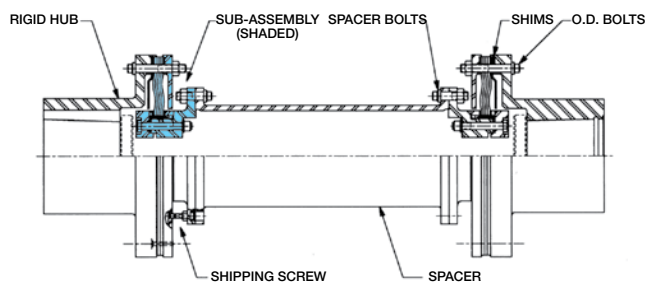

Fig. 5

Coupling Designation

Construction and Materials

Coupling Designation

#10-11 RR

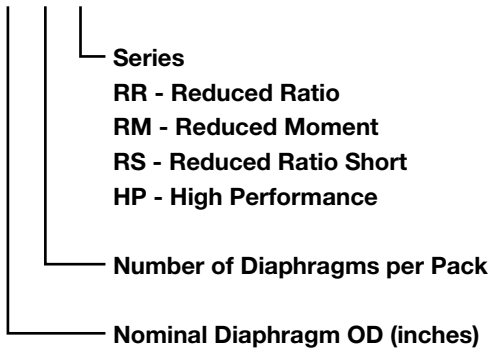

Materials Diaphragms

The standard grade of material used to manufacture the Ameriflex diaphragm is 15-5 PH stainless steel. This is a precipitation hardening grade of stainless steel that offers high strength while maintaining toughness. The corrosion resistance properties of 15-5 PH exceed the more commonly used grades of stainless steel. This has been proven by years of Ameriflex field experience in corrosive environments, including chlorine and hydrogen sulfide. In addition, all diaphragms are individually shot-peened and inspected. Shot-peening improves fatigue strength and resistance to stress corrosion. However, this increased fatigue strength is not used in our safety factor calculations.

The diaphragms are capable of operating at temperatures of -50°F (-45°C) to 600°F (315°C) without protective coatings. Consult Ameridrives for coupling ratings above 450°F (232°C).

Hubs, Adapters, Spacers

All remaining torque transmitting components of the Ameriflex coupling assembly are manufactured from high quality AISI-4140 alloy steel and heat treated to the required strength levels. These components are furnished with black oxide finish.

Hardware

The standard bolt used is manufactured from high quality alloy steel and heat treated 160,000 PSI minimum yield strength. The bolt head is a 12-point external wrenching design. Equivalent strength Grade C all-metal prevailing torque hex locknuts are used to secure the clamped connection. All standard hardware is plated for thread lubricity and corrosion resistance.

Shim Sets

Shims (Figure 9) are provided to adjust the effective length of the coupling at installation to accommodate variations in flange-to-flange dimensions when moving the connected equipment is difficult or impossible. The coupling spacer is intentionally made short by the thickness of one shim set. This allows for flange-to-flange adjustability of the total thickness of one shim set.

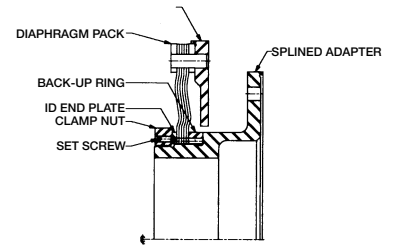

RR SERIES - SUB-ASSEMBLY
Fig. 6

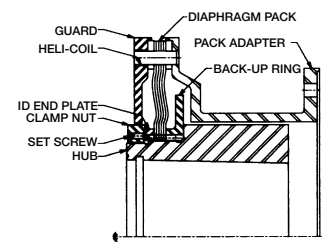

RM SERIES - SUB-ASSEMBLY
Fig. 7

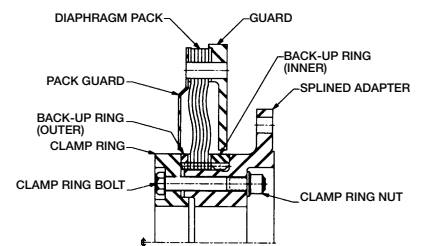

HP SERIES - SUB-ASSEMBLY
Fig. 8

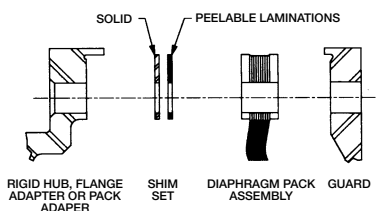

Fig. 9

Size Coupling	Shim Thickness, Quantity and Construction in (mm)	
5,6	.063 (1.600)	21 .003 (.076) peelable laminations
8-22	.125 (3.175)	21 .003 (.076) peelable laminations and 1 .062 (1.575) solid
28,34	.124 (3.150)	2 .062 (1.575) solid

Multiple Convoluted Diaphragm Pack

The heart of the Ameriflex multiple convoluted diaphragm coupling is the stainless steel diaphragm pack (Figure 10). The pack consists of several thin, convoluted diaphragms. The R Series pack consists of diaphragms with the flexing area machined thinner than the ID and OD. The resulting integral fillers (Figure 11) maintain separation of the flex area.

Construction of the HP Series has not changed, with uniform thickness diaphragms separated at the ID and OD by filler rings and segments (Figure 12).

The new integral filler design optimizes the shape and thickness of the diaphragms. The separate filler rings and segments have been eliminated, reducing the number of components and manufacturing processes.

It is the thin convoluted diaphragms in parallel that give Ameriflex couplings their flexibility while maintaining torque capacity. Stresses, moments and forces of a diaphragm increase with the third power of the thickness. The use of several thinner diaphragms produces substantially lower values than a single diaphragm coupling with equal flex element thickness. Lower forces can be achieved without sacrificing peak torque capability or relying on mechanical back-up systems. Mechanical back-up devices, which engage to transmit power in the event of transient peak torques, can increase the level of damaging forces transmitted to a system at the worst possible time.

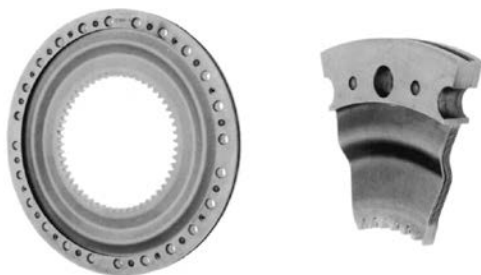

A major advantage in the use of the thin convoluted diaphragm is the reduction of undesirable moments and forces transmitted to the bearings of the connected equipment. The convoluted form permits accurate prediction of those moments and forces.

All styles of Ameriflex diaphragm packs have a constant axial stiffness with a single axial natural frequency. The unrolling action of the convolutions results in the diaphragm's large axial capacity and low stresses (Figure 13). Disc and contour diaphragms accommodate axial motion by pure deformation of material. In fact, once axial motion in a disc or contour diaphragm exceeds approximately one-half of the material thickness, stiffness and stresses become non-linear and increase exponentially. Therefore, predicting the axial force upon rotating equipment is very difficult for couplings that have a non-linear stiffness. A comparison of force versus axial travel of disc, contour diaphragm, and convoluted diaphragm couplings in Figure 14 demonstrates the stiffness variations.

The convolution provides for a constant stiffness over a larger range of axial travel than does a disc or contoured diaphragm. The multiple convoluted diaphragm coupling has a distinct advantage over gear couplings in axial force and misalignment moment predictability.

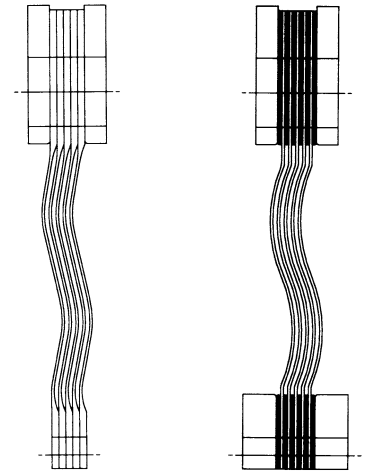

Fig. 11

Fig. 12



Fig. 13

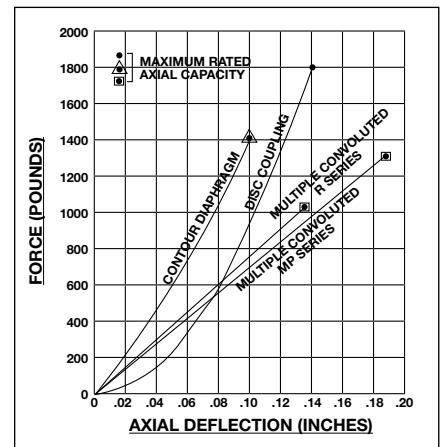
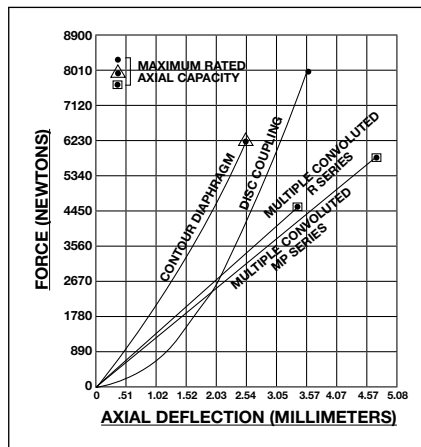

Fig. 14

Multiple Convoluted Diaphragm Pack

Safety Feature

Multiple separated diaphragms provide an additional safety feature. The stresses in each diaphragm in a pack are not equal due to the offset stress as shown in Figure 15. Therefore, if a fatigue failure was to occur due to overmisalignment, the outer diaphragm will fail first. Since the diaphragm flex areas are separated, one failed diaphragm will not necessitate the next to fail. The next diaphragm will have a lower combined alternating stress than the first, due to a lower offset stress.

If machinery operations continue and the next outermost diaphragms continue to fail, the decreasing stress effect would continue until approximately one-half of the diaphragms have failed. Then the torque component of stress would cause the remaining diaphragms to fail in torsion.

As a failed diaphragm continues to operate, cracks can develop into broken pieces. These will centrifuge and be caught in the guard. Most turbomachinery today incorporates vibration monitoring equipment designed to detect any unbalance by such a failed diaphragm. A total failure could also be prevented by inspection of the coupling, at normal maintenance periods, for cracks or distress areas in the outer diaphragm of the pack.

Design Variables

Steady state stresses have a definite relationship to each other. A decrease in a steady state stress, such as shear stress due to torque, allows for an increase in another steady state stress, such as axial stress due to equipment shaft movement, or centrifugal stress due to speed. Curves are provided for Series RR/RM/RS Ameriflex with the standard number of diaphragms, to define this relationship and assist the user in coupling selection process. It is also possible to vary the number of diaphragms per pack to suit special applications. Consult Ameridrives Couplings for ratings.

Ameriflex Diaphragm Stress Analysis

The Ameriflex multiple convoluted diaphragm is designed for infinite life based on the constant life diagram. Figure 16 shows typical results for the RR Series.

Mean stresses (torsional, axial and centrifugal) are induced by steady state torsional loading, steady state axial deflections and coupling rotation. Alternating stresses (torsional, axial, flexure and offset) are a result of alternating torsional loading, cyclic axial deflections, and equipment misalignment or offset.

The design analysis for the Ameriflex diaphragm begins with calculating the directional stresses (radial, tangential and shear) for each of the load conditions described above. The actual stress equations are derived from finite element analysis (FEA). The strong correlation of FEA to strain gage testing (Figure 17) confirms that a two-dimensional analysis is appropriate for the diaphragm configuration.

These directional stresses are combined to obtain the maximum and minimum principle stress for both the mean and alternating conditions. The von-Mises or distortion energy theory is then used to obtain the combined mean and alternating stresses. Finally, these combined stresses are used to calculate the combined constant life safety factor as shown in Figure 16. The minimum cyclic safety factor for the alternating stresses is 2.0.

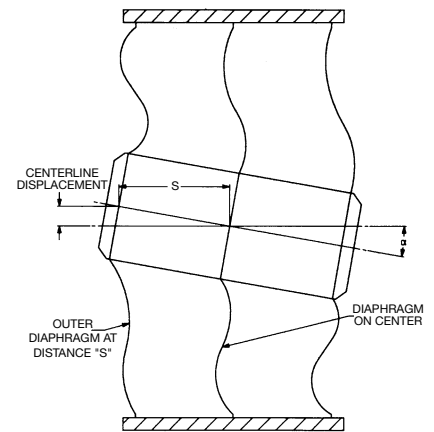

Fig. 15

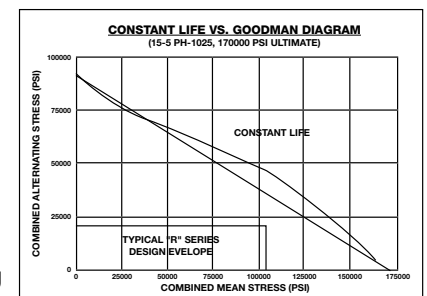

Fig. 16

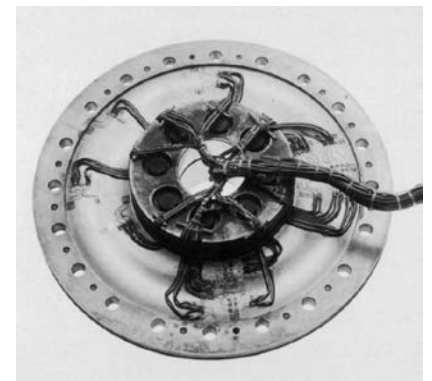

Fig. 17

Coupling Selection

Step 1 - Selection Torque

Calculate selection torque (T) from:

$$T = \frac{HP \times 63025 \times SF}{RPM}$$

$$T = \frac{kw \times 9549 \times SF}{RPM}$$

SF = Service factor from chart
(Page 9, Figure 19)

NOTE: For API-671, applications use a
1.75 SF unless otherwise specified.

CAUTION:

Generator short circuit, compressor surge, electric motor starts and other applications can result in single cycle peak torques. Synchronous motors and reciprocating engines can exhibit high multiple cycle peak torques. It is important that these peak torques be considered when selecting a high performance coupling. We will assume a peak torque equal to 7 x normal operating torque for generator drives or synchronous motor drives unless otherwise specified.

Step 2 - Axial Travel Requirements

It is important to identify the movement of the drive and driven equipment shaft ends relative to a reference point, with the negative direction being toward the bearing and positive being away from the bearing. Shaft end movement occurs as a result of thermal changes in housing and shafts as well as fluid thrust. Axial travel requirements should be evaluated at start-up, transient operating conditions, shut down and normal operation.

Ameridrives recommends installing high performance dry couplings with pre-stretch to reduce axial forces during operation. Where application conditions allow, the coupling should be installed with pre-stretch equal to the thermal growth from cold to hot normal operation.

Step 3 - Coupling Series Selection

The following guidelines are suggested to assist in initial selection of the coupling series:

RR Series - Should be the initial selection unless torque requirement is greater than a size 16 rating or the rotor dynamic concerns dictate a Reduced Moment (RM) design.

RS Series - Should be selected if distance between shaft ends is less than the minimum for RR selection. The HP series short shaft-to-shaft design will be provided for sizes 19 and larger.

RM Series - Ideal selection if low overhung moment is required.

HP Series - Select if axial travel or torque capacities of R Series design does not satisfy the requirements of the application. This series is also appropriate when minimal axial or bending stiffness is required.

Step 4 - Coupling Size Selection

The initial selection is determined by choosing a continuous torque rating value that is equal to or greater than the calculated selection torque value. See pages 10-16 for initial selection based on torque and axial travel requirements. Graphs are provided for the R Series couplings to permit selection of maximum torque capacity based on application torque capacity based on application torque capacity based on application axial requirements. See example.

Step 5

Check bore, peak torque, misalignment and speed capacities and envelope restrictions to confirm initial selection.

Contact Ameridrives:

1. If speed or misalignment requirements exceed catalog values.
2. If reduced axial or bending stiffness is required.

See page 19 for special retrofit considerations.

For assistance in selection, fill out and return pages 22 and 23 with your specific application requirements.

Step 4 Example

35,000 HP (26,100 kw) gas turbine driving centrifugal compressor at 5000 RPM, API-671 applies, axial travel requirements is $\pm .190$ inches (± 4.83 mm).

$$T = \frac{35,000 \times 63,025 \times 1.75}{5,000} = 772,056 \text{ in.lb.}$$

$$T = \frac{26,100 \times 9,549 \times 1.75}{5,000} = 87,230 \text{ Nm}$$

NOTE: Service Factors applied incorrectly will increase coupling size and weight unnecessarily. If coupling selection with Service Factor is too heavy or large, consult Ameridrives. Factors should be applied to normal operating torques only.

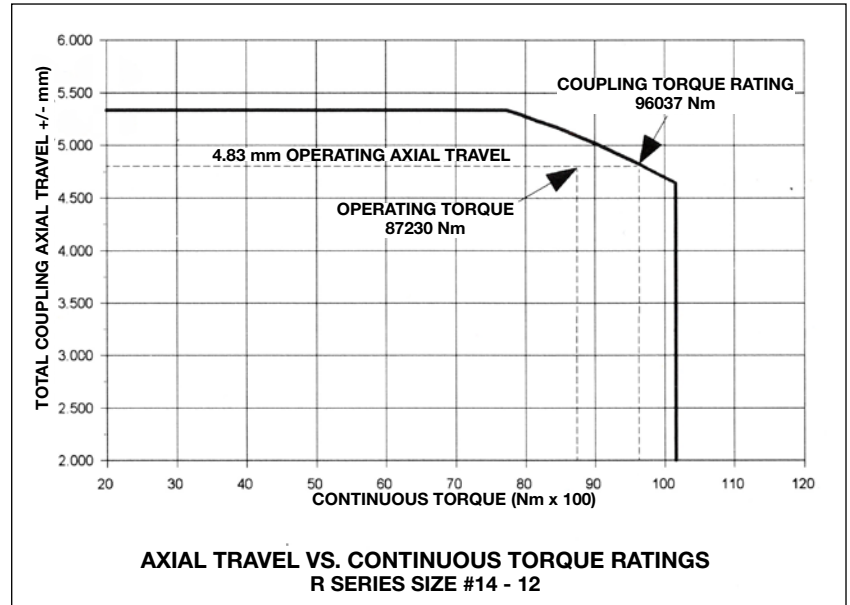
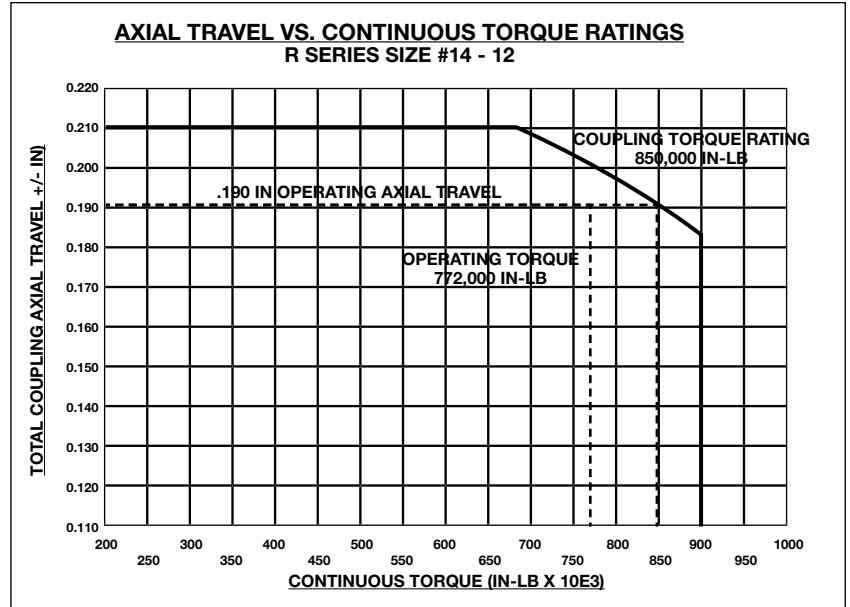

Fig. 18

From table on page 10, select size 14-12RR, then confirm axial travel and torque capacity from graph on page 11; see Figure 18. **Note:** Coupling torque rating will be 850,000 in.lb. (96,037Nm) Total axial capacity is .380 in. (9,652 mm)

SERVICE FACTORS				
LOAD	DRIVEN EQUIPMENT	TYPE DRIVER		API-671*
		STEAM OR GAS TURBINE	ELECTRIC MOTOR	
CONSTANT TORQUE	CENTRIFUGAL PUMPS AND COMPRESSORS; CONVEYORS, GENERATORS, LIGHT FANS	1.00	1.25	1.75
MODERATE TORQUE FLUCTUATIONS	LARGE FANS, SCREW COMPRESSORS AND PUMPS	1.50	1.75	1.75

Fig. 19

* American Petroleum Institute

RR Series Engineering Data

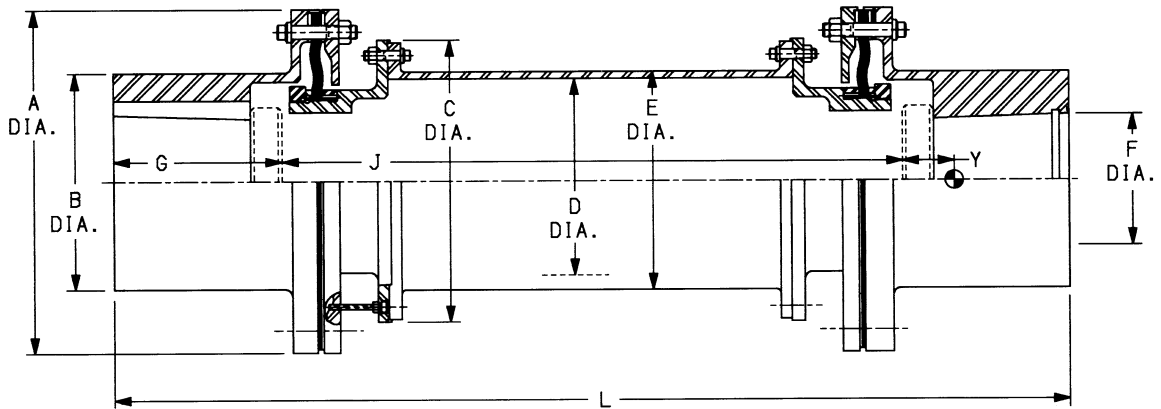

Coupling Data - RR Series (Reduced Ratio)

Coupling Size	①③	①②	④	Half Coupling ⑤				Spacer Tube/in. (mm)		
	Max. Continuous Torque Rating In. Lb. x 1000 (Nm x 1000)	Peak Torque Rating In. Lb. x 1000 (Nm x 1000)		Rated Speed RPM	Wt. Lb. (kg)	WR ² Lb.In ² (kgm ² x E-02)	Y C.G.	KT In.Lb./ Rad. x 10 ⁶ (kg-mm/rad. x E + 06)	Wt. Lb. (kg x E-03)	WR ² Lb.Inc. (kgm ² x E-05)
5-9	56.7 (6.41)	85 (9.60)	20,000	11.6 (5.26)	47 (1.38)	-.28 (-7.11)	3.32 (38.25)	.3 (5.36)	1 (1.15)	39.89 (11,673.40)
6-10	93.3 (10.54)	140 (15.82)	18,000	17.3 (7.85)	92 (2.69)	-.08 (-2.03)	6.33 (72.93)	.4 (7.14)	2 (2.30)	80.06 (23,428.73)
8-8	173 (19.55)	260 (29.38)	15,000	38.0 (17.24)	328 (9.60)	.24 (6.10)	15.76 (181.57)	.7 (12.50)	5 (5.76)	188.04 (55,027.96)
10-11	331 (37.40)	496 (56.04)	13,000	64.2 (29.12)	847 (24.79)	.05 (1.27)	33.8 (389.42)	1.0 (17.86)	12 (13.83)	489.59 (143,273.46)
12-10	640 (72.31)	960 (108.47)	10,000	107.9 (48.94)	1,980 (57.94)	.45 (11.43)	67.2 (774.23)	1.6 (28.57)	27 (31.11)	1,104.43 (323,200.03)
14-12	900 (101.69)	1,350 (152.53)	10,000	148.6 (67.40)	3,637 (106.43)	.11 (2.79)	106.2 (1,223.56)	2.1 (37.50)	46 (53.00)	1,864.85 (545,729.09)
16-9	1,400 (158.18)	2,100 (237.27)	10,000	198.1 (89.86)	6,063 (177.43)	.45 (11.43)	168.77 (1,944.44)	3.0 (53.57)	90 (103.69)	3,669.02 (1,073,700.81)
22-15 ^⑥	4,000 (451.94)	9,000 (1,016.86)	6,000	628.3 (284.99)	34,400 (1,006.74)	-1.10 (-27.94)	575.12 (6,626.10)	7.8 (139.29)	315 (362.92)	12,773.40 (3,737,980.19)

① All ratings at .25° misalignment. Higher misalignments available; consult Ameridrives.

② Peak torque rating is at maximum axial travel rating.

③ For axial travel rating, see axial travel vs. continuous torque ratings curve.

④ Higher speeds available. Consult Ameridrives for torque capacities at higher than rated speed.

⑤ Weight, WR² and KT based on J=18 inch SH-SH (457.2mm or minimum SH-SH, whichever is greater), and nominal bores.

⑥ Torque applicable up to rated axial travel of .200 inches (5.080mm).

Dimensions inches (mm)

Coupling Size	Coupling O.D. A	Barrel Dia. B Max.	Flange Dia. C	Spacer I.D. D	Spacer O.D. E	Bore Dia. F Nominal	Bore Dia. F Max.	Shaft Length G	Shaft-to-Shaft J Min.	Coupling Length L	Stiffness per Diaphragm ⑧	
											Axial Stiffness Lb.in. (N/mm)	Bending Stiffness In.Lb./Degree (Nm/Degree)
5	5.97 (151.64)	4.56 (115.82)	5.00 (127.00)	3.50 (88.90)	3.69 (93.73)	2.00 (50.80)	3.25 (82.55)	2.44 (61.98)	7.50 (190.50)	22.88 (581.15)	1,250 (219)	100 (11)
6	6.94 (176.28)	5.44 (138.18)	5.94 (150.88)	4.44 (112.78)	4.63 (117.60)	2.50 (63.50)	3.75 (95.25)	3.03 (76.96)	7.50 (190.50)	24.06 (611.12)	1,200 (210)	120 (14)
8	8.97 (227.84)	7.25 (184.15)	6.94 (176.28)	5.09 (129.29)	5.38 (136.65)	3.50 (88.90)	5.00 (127.00)	4.19 (106.43)	8.56 (217.42)	26.38 (670.05)	2,200 (385)	440 (50)
10	10.94 (277.88)	8.50 (215.90)	8.97 (227.84)	6.81 (172.97)	7.13 (181.10)	4.00 (101.60)	6.00 (152.40)	4.75 (120.65)	10.19 (258.83)	27.50 (698.50)	1,700 (298)	400 (45)
12	12.94 (328.68)	10.62 (269.75)	10.94 (277.88)	8.00 (203.20)	8.44 (214.38)	5.00 (127.00)	7.50 (190.50)	6.03 (153.16)	11.38 (289.05)	30.06 (763.52)	2,300 (403)	880 (99)
14	14.75 (374.65)	12.12 (307.85)	12.06 (306.32)	9.13 (231.90)	9.63 (244.60)	5.50 (139.70)	8.50 (215.90)	6.03 (153.16)	13.44 (341.38)	30.06 (763.52)	2,200 (385)	950 (107)
16	16.94 (430.28)	14.00 (355.60)	13.69 (347.73)	10.63 (270.00)	11.25 (285.75)	6.00 (152.40)	10.00 (254.00)	7.22 (183.99)	13.69 (347.73)	32.44 (823.98)	3,800 (665)	2,550 (288)
22	22.38 (568.45)	18.88 (479.55)	19.88 (504.95)	12.00 (304.80)	13.38 (339.85)	9.00 (228.60)	13.50 (342.90)	10.88 (276.35)	23.12 (587.25)	44.88 (1,139.95)	5,000 (876)	4,046 (457)

⑦ Coupling length based on J = 18 inch SH-SH (457.2mm or minimum SH-SH, whichever is greater).

⑧ Coupling Axial Stiffness lb.in. (N/mm) = $\frac{\text{No. of Diaphragms}}{2} \times \text{Diaphragm Axial Stiffness}$.

Coupling Bending Stiffness in.lb. (Nm)/Degree = No. of Diaphragms x Diaphragm Bending Stiffness.

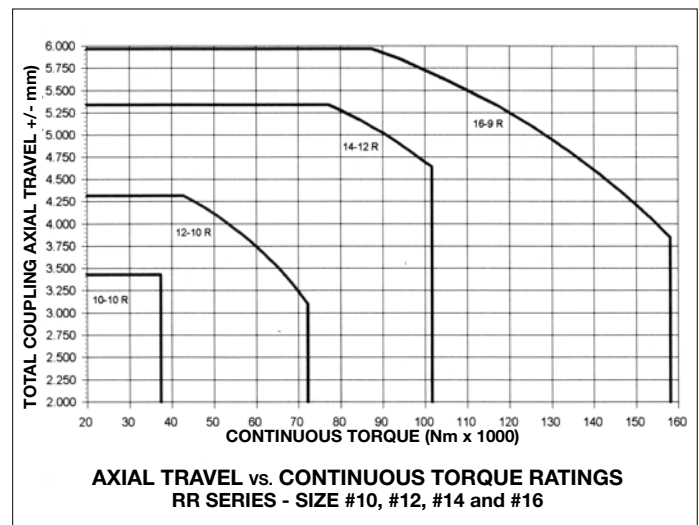
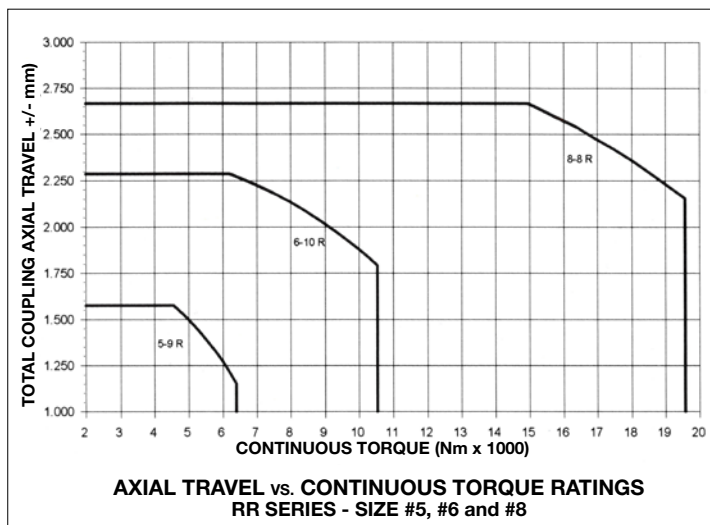
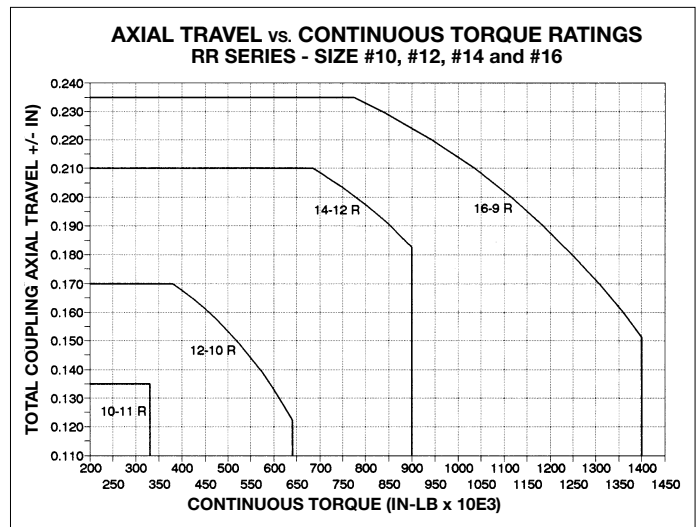
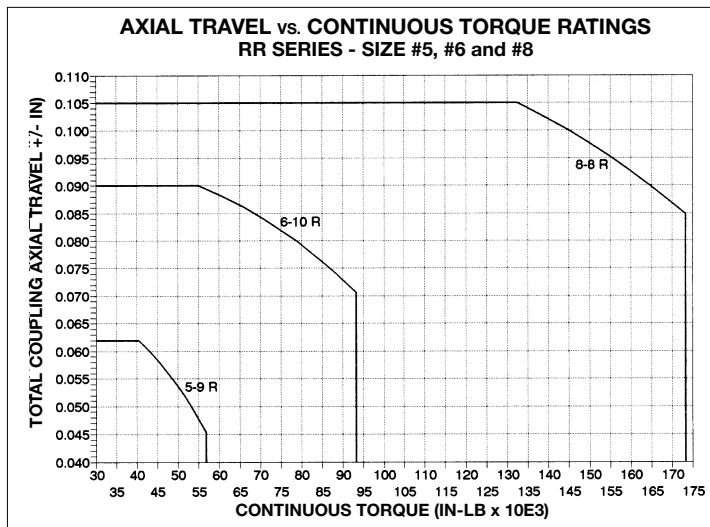

RM Series Engineering Data

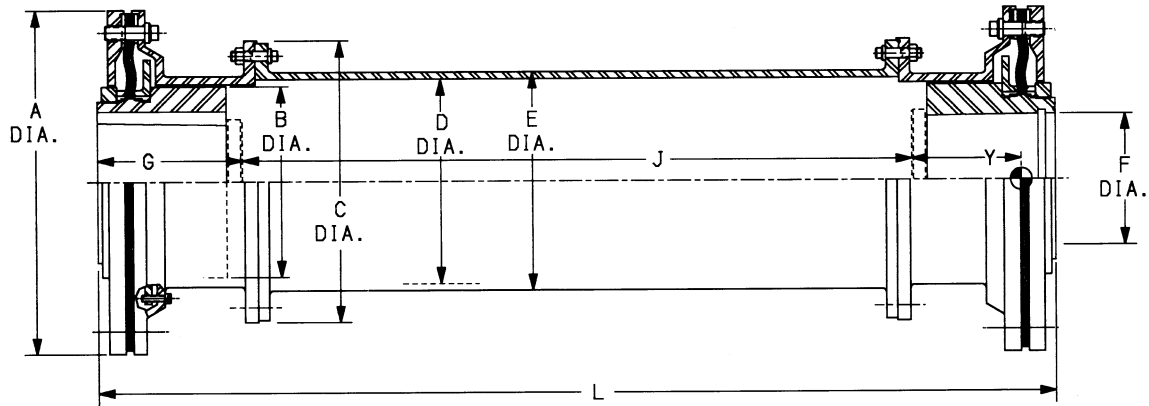

Coupling Data - RM Series (Reduced Moment)

Coupling Size	①③	①②	④	Half Coupling ⑤				Spacer Tube/in. (mm)		
	Max. Continuous Torque Rating In. Lb. x 1000 (Nm x 1000)	Peak Torque Rating In. Lb. x 1000 (Nm x 1000)		Rated Speed RPM	Wt. Lb. (kg)	WR ² Lb.In ² (kgm ² x E-02)	Y C.G.	KT In.Lb./ Rad. x 10 ⁶ (kg-mm/rad. x E + 06)	Wt. Lb. (kg x E-03)	WR ² Lb.Inc. (kgm ² x E-05)
5-7	43.3 (4.89)	65 (7.34)	20,000	10.2 (4.63)	40 (1.17)	1.66 (42.16)	3.21 (36.98)	.3 (5.36)	1 (1.15)	39.89 (11,673.40)
6-8	76.7 (8.67)	115 (12.99)	18,000	15.8 (7.17)	85 (2.49)	2.13 (54.10)	5.71 (65.79)	.4 (7.14)	2 (2.30)	80.06 (23,428.73)
8-7	166 (18.76)	250 (28.25)	15,000	30.9 (14.02)	261 (7.64)	2.77 (70.36)	12.46 (143.55)	.7 (12.50)	5 (5.76)	188.04 (55,027.96)
10-9	290 (32.77)	435 (49.15)	13,000	55.0 (24.95)	707 (20.69)	3.29 (83.57)	28.48 (328.13)	1.0 (17.86)	12 (13.83)	489.59 (143,273.46)
12-8	517 (58.41)	775 (87.56)	10,000	92.1 (41.78)	1,646 (48.17)	3.74 (95.00)	54.16 (623.99)	1.6 (28.57)	27 (31.11)	1,104.43 (323,200.03)
14-10	750 (84.74)	1,125 (127.11)	10,000	127.1 (57.65)	3,030 (88.67)	4.32 (109.73)	90.29 (1,040.25)	2.1 (37.50)	46 (53.00)	1,864.85 (545,729.09)
16-8	1,200 (135.58)	1,800 (203.37)	10,000	199.4 (90.45)	5,887 (172.28)	5.76 (146.30)	140.59 (1,619.77)	3.0 (53.57)	90 (103.69)	3,669.02 (1,073,700.81)
22-15 [Ⓞ]	4,000 (451.94)	9,000 (1,016.86)	6,000	556.6 (252.47)	31,705 (927.84)	-7.75 (-196.85)	449.64 (5,180.41)	7.8 (139.29)	315 (362.92)	12,773.40 (3,737,980.19)

① All ratings at .25° misalignment. Higher misalignments available; consult Ameridrives.

② Peak torque rating is at maximum axial travel rating.

③ For axial travel rating, see axial travel vs. continuous torque ratings curve.

④ Higher speeds available. Consult Ameridrives for torque capacities at higher than rated speed.

⑤ Weight, WR² and KT based on J=18 inch SH-SH (457.2mm or minimum SH-SH, whichever is greater), and nominal bores.

⑥ Torque applicable up to rated axial travel of .200 inches (5.080mm).

Dimensions inches (mm)

Coupling Size	Coupling O.D. A	Barrel Dia. B Max.	Flange Dia. C	Spacer I.D. D	Spacer O.D. E	Bore Dia. F Max.	Shaft Length G	Shaft-to-Shaft J Min.	⑦ Coupling Length L	Stiffness per Diaphragm ⑧	
										Axial Stiffness Lb.in. (N/mm)	Bending Stiffness In.Lb./Degree (Nm/Degree)
5	5.97 (151.64)	3.25 (82.55)	5.00 (127.00)	3.50 (88.90)	3.69 (93.73)	2.25 (57.15)	2.44 (61.98)	3.88 (98.55)	22.88 (581.15)	1,250 (219)	100 (11)
6	6.94 (176.28)	3.83 (97.28)	5.94 (150.88)	4.44 (112.78)	4.63 (117.60)	2.50 (63.50)	3.03 (76.96)	4.62 (117.35)	24.06 (611.12)	1,200 (210)	120 (14)
8	8.97 (227.84)	4.84 (122.94)	6.94 (176.28)	5.09 (129.29)	5.38 (136.65)	3.25 (82.55)	3.59 (91.19)	4.12 (104.65)	25.19 (639.57)	2,200 (385)	440 (50)
10	10.94 (277.88)	5.99 (152.15)	8.97 (227.84)	6.81 (172.97)	7.13 (181.10)	4.00 (101.60)	4.75 (120.65)	4.44 (112.78)	27.50 (698.50)	1,700 (298)	400 (45)
12	12.94 (328.68)	7.25 (184.15)	10.94 (277.88)	8.00 (203.20)	8.44 (214.38)	4.50 (114.30)	5.31 (134.87)	6.19 (157.23)	28.62 (726.95)	2,300 (403)	880 (99)
14	14.75 (374.65)	8.12 (206.25)	12.06 (306.32)	9.13 (231.90)	9.63 (244.60)	5.50 (139.70)	6.03 (153.16)	6.62 (168.15)	30.06 (763.52)	2,200 (385)	950 (107)
16	16.94 (430.28)	9.75 (247.65)	13.69 (347.73)	10.63 (270.00)	11.25 (285.75)	6.50 (165.10)	8.00 (203.20)	8.69 (220.73)	34.00 (863.60)	3,800 (665)	2,550 (288)
22	22.38 (568.45)	13.38 (339.85)	19.88 (504.95)	12.00 (304.80)	13.38 (339.85)	9.00 (228.60)	10.88 (276.35)	10.88 (276.35)	23.12 (587.25)	5,000 (876)	4,046 (457)

⑦ Coupling length based on J = 18 inch SH-SH (457.2mm or minimum SH-SH, whichever is greater).

⑧ Coupling Axial Stiffness lb.in. (N/mm) = $\frac{\text{No. of Diaphragms}}{2}$ x Diaphragm Axial Stiffness.

Coupling Bending Stiffness in.lb. (Nm)/Degree = No. of Diaphragms x Diaphragm Bending Stiffness.

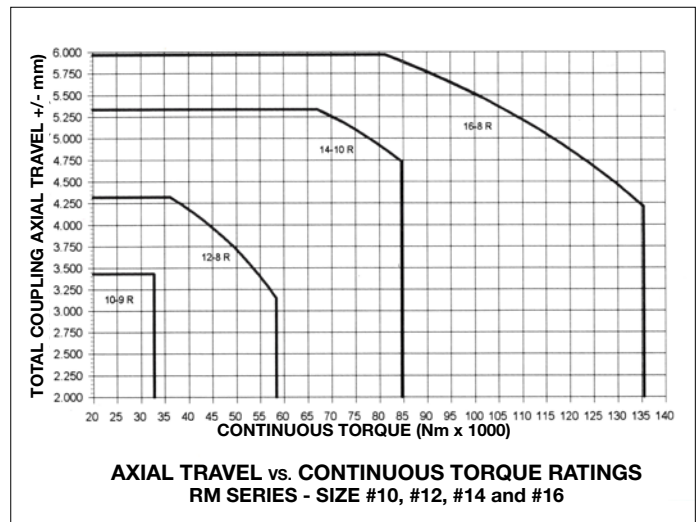
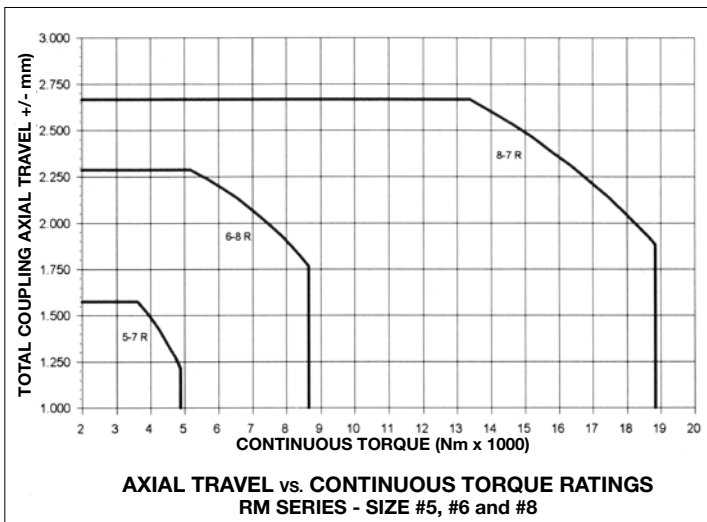
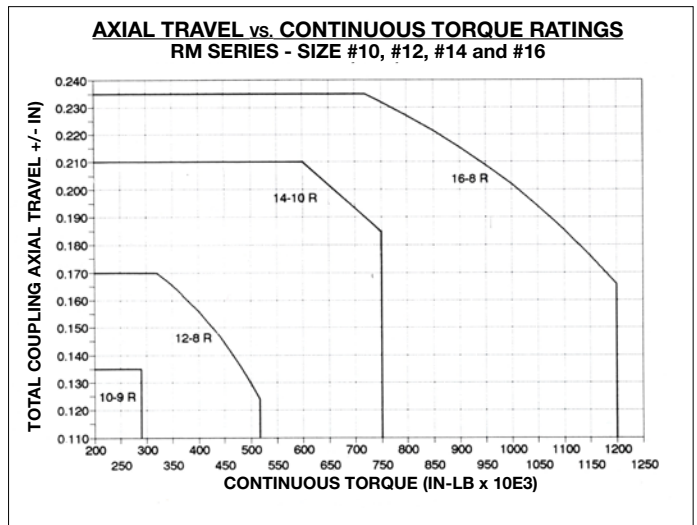
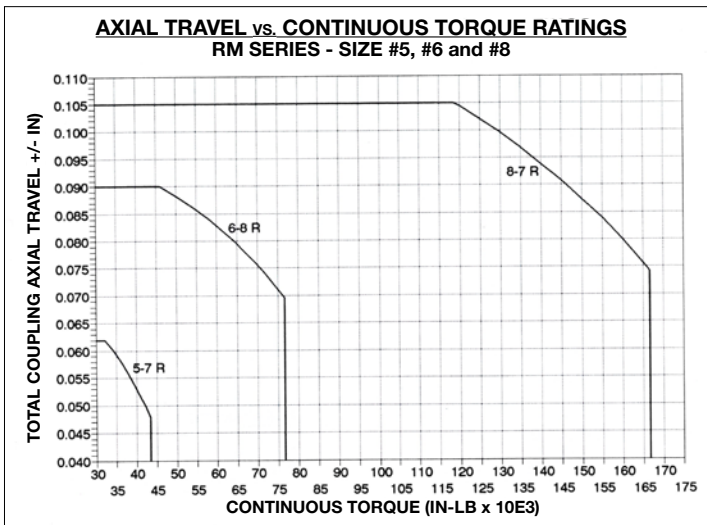

RS Series Engineering Data

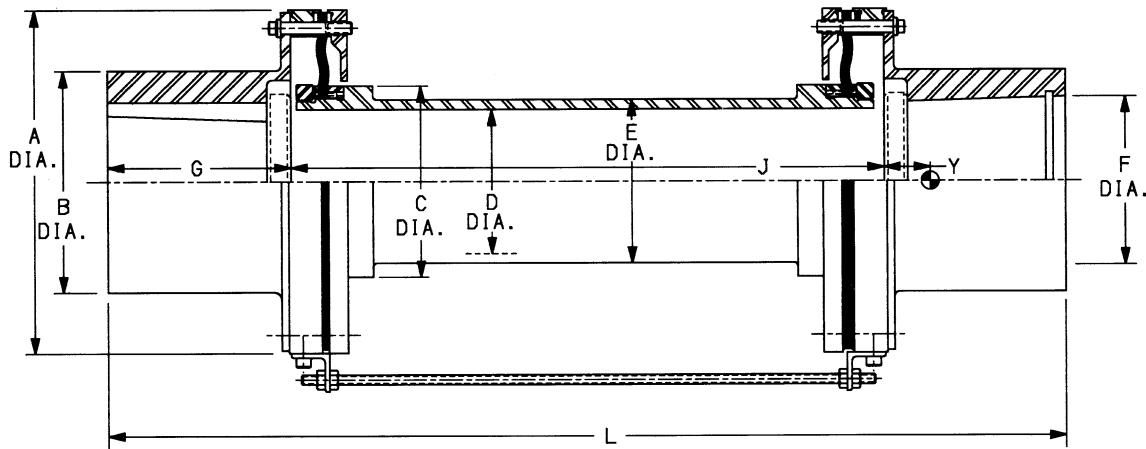

Coupling Data - RS Series (Reduced Short)

Coupling Size	①③	①②	④	Half Coupling ⑤				Spacer Tube/in. (mm)		
	Max. Continuous Torque Rating In. Lb. x 1000 (Nm x 1000)	Peak Torque Rating In. Lb. x 1000 (Nm x 1000)		Rated Speed RPM	Wt. Lb. (kg)	WR ² Lb.In ² (kgm ² x E-02)	Y C.G.	KT In.Lb./ Rad. x 10 ⁶ (kg-mm/rad. x E + 06)	Wt. Lb. (kg x E-03)	WR ² Lb.Inc. (kgm ² x E-05)
5-9	56.7 (6.41)	85 (9.60)	20,000	11.3 (5.13)	43 (1.26)	-.08 (-2.03)	2.59 (29.84)	.4 (7.14)	1 (1.15)	26.29 (7,693.50)
6-10	93.3 (10.54)	140 (15.82)	18,000	17.7 (8.03)	84 (2.46)	.04 (1.02)	5.71 (65.79)	.6 (10.71)	2 (2.30)	62.08 (18,167.07)
8-8	173 (19.55)	260 (29.38)	15,000	36.9 (16.74)	301 (8.81)	.42 (10.67)	14.77 (170.17)	1.0 (17.86)	4 (4.61)	161.29 (47,199.85)
10-11	331 (37.40)	496 (56.04)	13,000	60.0 (27.22)	746 (21.83)	.34 (8.64)	29.34 (338.03)	1.5 (26.79)	8 (9.22)	342.30 (100,170.56)
12-10	640 (72.31)	960 (108.47)	10,000	100.5 (45.59)	1,771 (51.83)	.80 (20.32)	56.96 (687.70)	2.1 (37.50)	17 (19.59)	686.23 (200,818.12)
14-12	900 (101.69)	1,350 (152.53)	10,000	134.2 (60.87)	3,170 (108.57)	.60 (15.24)	91.23 (1,051.08)	2.7 (48.22)	28 (32.26)	1,155.80 (338,232.93)
16-9	1,400 (158.18)	2,100 (237.27)	10,000	182.0 (82.55)	5,423 (158.70)	.88 (22.35)	155.74 (1,794.32)	3.7 (66.07)	59 (67.98)	2,379.79 (696,420.97)
22-15 [Ⓞ]	4,000 (451.94)	9,000 (1,016.86)	6,000	534.1 (242.26)	28,810 (843.12)	-1.69 (-42.93)	604.48 (6,964.36)	9.6 (171.44)	269 (309.92)	10,966.00 (3,209,066.17)

① All ratings at .25° misalignment. Higher misalignments available; consult Ameridrives.

② Peak torque rating is at maximum axial travel rating.

③ For axial travel rating, see axial travel vs. continuous torque ratings curve.

④ Higher speeds available. Consult Ameridrives for torque capacities at higher than rated speed.

⑤ Weight, WR² and KT based on J=18 inch SH-SH (457.2mm or minimum SH-SH, whichever is greater), and nominal bores.

⑥ Torque applicable up to rated axial travel of .200 inches (5.080mm).

Dimensions inches (mm)

Coupling Size	Coupling O.D. A	Barrel Dia. B Max.	Shoulder Dia. C	Spacer I.D. D	Spacer O.D. E	Bore Dia. F Nominal	Bore Dia. F Max.	Shaft Length G	Shaft-to-Shaft J Min.	⑦ Coupling Length L	Stiffness per Diaphragm ⑧	
											Axial Stiffness Lb.In. (N/mm)	Bending Stiffness In.Lb./Degree (Nm/Degree)
5	5.97 (151.64)	4.56 (115.82)	3.29 (83.57)	2.50 (63.50)	2.81 (71.37)	2.00 (50.80)	3.25 (82.55)	2.44 (61.98)	3.00 (76.20)	22.88 (581.15)	1,250 (219)	100 (11)
6	6.94 (176.28)	5.44 (138.18)	3.86 (98.04)	4.84 (122.14)	3.31 (84.07)	2.50 (63.50)	3.75 (95.25)	3.03 (76.96)	3.06 (77.72)	24.06 (611.12)	1,200 (210)	120 (14)
8	8.97 (227.84)	7.25 (184.15)	4.97 (126.24)	3.68 (93.47)	4.25 (107.95)	3.50 (88.90)	5.00 (127.00)	4.19 (106.43)	3.75 (95.25)	26.38 (670.05)	2,200 (385)	440 (50)
10	10.94 (277.88)	8.50 (215.90)	5.83 (148.08)	4.38 (111.25)	5.09 (129.29)	4.00 (101.60)	6.00 (152.40)	4.75 (120.65)	4.50 (114.30)	27.50 (698.50)	1,700 (298)	400 (45)
12	12.94 (328.68)	10.62 (269.75)	6.98 (177.29)	5.31 (134.87)	6.12 (155.45)	5.00 (127.00)	7.50 (190.50)	6.03 (153.16)	5.00 (127.00)	30.06 (763.52)	2,300 (403)	880 (99)
14	14.75 (374.65)	12.12 (307.85)	7.83 (198.88)	6.00 (152.40)	6.94 (176.28)	5.50 (139.70)	8.50 (215.90)	6.03 (153.16)	5.50 (139.70)	30.06 (763.52)	2,200 (385)	950 (107)
16	16.94 (430.28)	14.00 (355.60)	9.50 (241.30)	7.38 (187.45)	8.44 (214.38)	6.00 (152.40)	10.00 (254.00)	7.22 (183.39)	5.50 (139.70)	32.44 (823.98)	3,800 (665)	2,550 (288)
22	22.38 (568.45)	18.88 (479.55)	13.38 (339.85)	9.50 (241.30)	11.56 (293.62)	9.00 (228.60)	13.50 (342.90)	10.88 (276.35)	7.50 (190.50)	39.76 (1,009.90)	5,000 (876)	4,046 (457)

⑦ Coupling length based on J = 18 inch SH-SH (457.2mm or minimum SH-SH, whichever is greater).

⑧ Coupling Axial Stiffness lb.in. (N/mm) = $\frac{\text{No. of Diaphragms}}{2}$ x Diaphragm Axial Stiffness.

Coupling Bending Stiffness in.lb. (Nm)/Degree = No. of Diaphragms x Diaphragm Bending Stiffness.

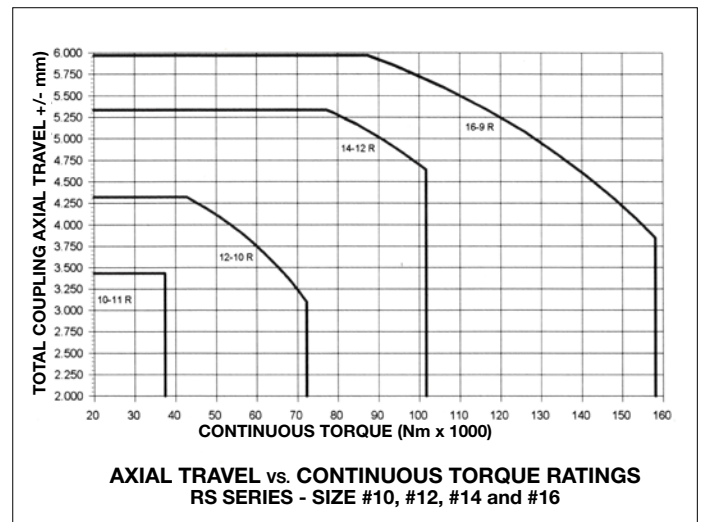
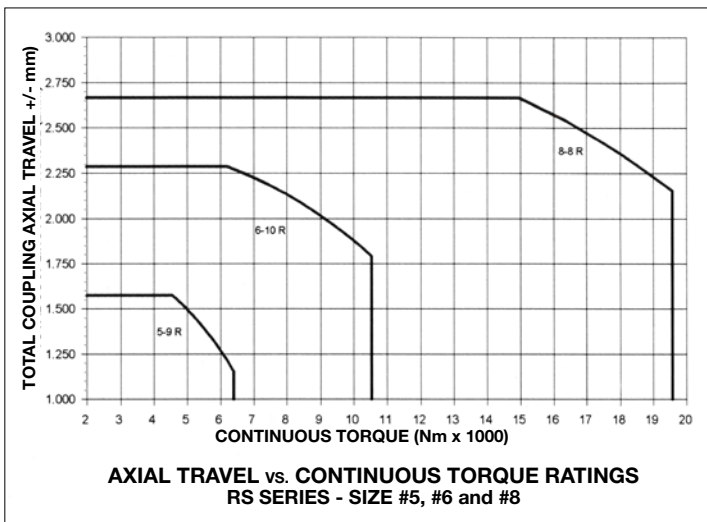
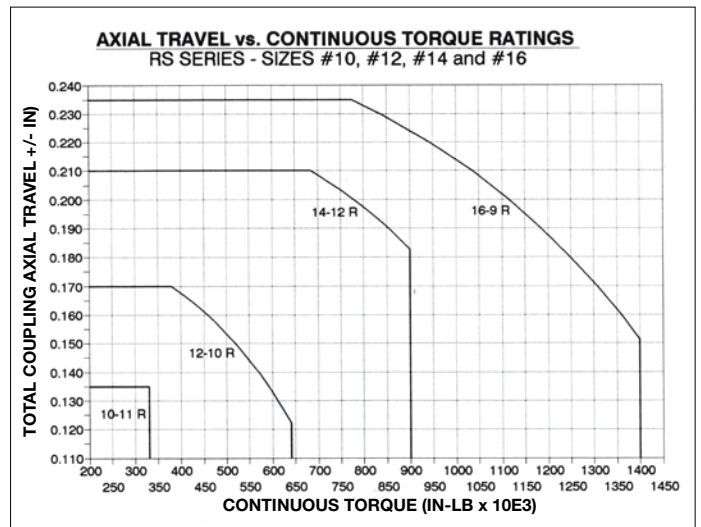
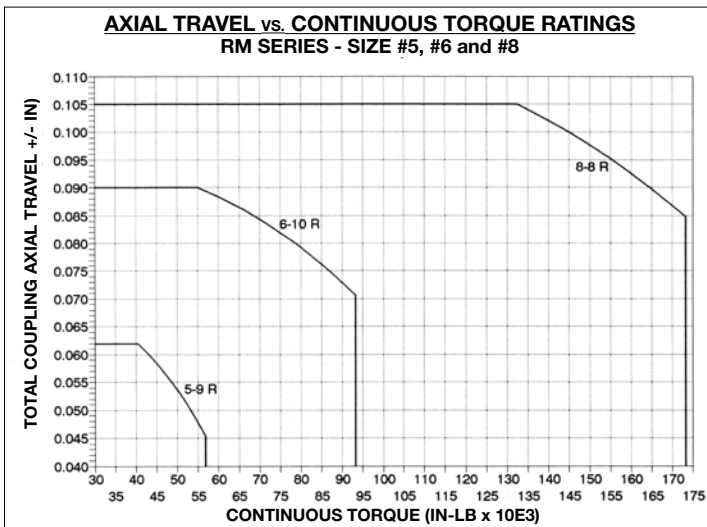

HP Series Engineering Data

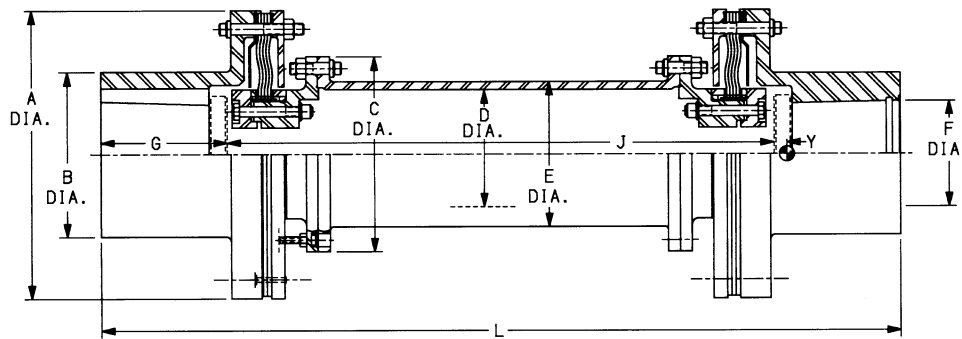

Coupling Data - HP Series (High Performance)

Coupling Size	① Max. Continuous Torque Rating In. Lb. x 1000 (Nm x 1000)	①④ Peak Torque Rating In. Lb. x 1000 (Nm x 1000)	Coupling Axial Travel (± In.) (± mm.)	② Rated Speed RPM	Half Coupling ③			Spacer Tube/in. (mm)			
					Wt. Lb. (kg)	WR ² Lb.In ² (kgm ² x E-02)	Y C.G.	KT In.Lb./Rad. x 10 ⁶ (kg-mm/rad. x E + 06)	Wt. Lb. (kg x E-03)	WR ² Lb.Inc. (kgm ² x E-05)	KT In.Lb. Rad. x 10 ⁶ (kg-mm/rad. x E + 06)
5-8	30 (3.39)	45 (5.08)	.100 (2.54)	20,000	12.4 (5.62)	40 (1.17)	-.45 (-11.43)	1.70 (19.59)	.3 (5.36)	.5 (0.58)	19.10 (5,589.42)
6-12	64 (7.23)	96 (10.85)	.125 (3.18)	18,000	19.3 (8.75)	83 (2.43)	-.35 (-8.89)	3.64 (41.94)	.4 (7.14)	1 (1.15)	41.61 (12,176.74)
8-12	160 (18.08)	250 (28.25)	.150 (3.81)	15,000	45.0 (20.41)	333 (9.74)	-.26 (-6.60)	11.11 (128.00)	.9 (16.07)	3 (3.46)	130.93 (38,315.31)
10-14	300 (33.90)	450 (50.84)	.187 (4.75)	13,000	73.3 (33.25)	880 (25.75)	-.34 (-8.64)	24.79 (285.61)	1.2 (21.43)	8 (9.22)	327.48 (95,833.64)
12-12	500 (56.49)	750 (84.74)	.216 (5.49)	10,000	120.8 (54.79)	1,950 (57.06)	-.06 (-1.52)	43.51 (501.29)	1.8 (32.14)	15 (17.28)	605.42 (177,169.91)
14-15	660 (74.57)	1,000 (112.98)	.275 (6.99)	10,000	164.1 (74.43)	3,625 (106.08)	-.40 (-10.16)	69.24 (797.73)	2.0 (35.72)	22 (25.35)	896.27 (262,284.16)
16-10	675 (76.26)	1,650 (186.42)	.312 (7.92)	10,000	230.0 (104.33)	6,421 (187.90)	-.44 (-11.18)	102.73 (1,183.58)	2.5 (44.64)	34 (39.17)	1,395.61 (408,410.85)
19-14	1,400 (158.18)	3,000 (338.95)	.375 (9.53)	8,000	408.8 (185.43)	15,916 (465.77)	-.72 (-18.29)	167.71 (1,932.23)	4.2 (75.00)	66 (76.04)	2,669.71 (781,263.06)
22-15	2,700 (305.06)	4,100 (463.24)	.410 (10.41)	7,000	614.9 (278.91)	31,914 (933.93)	.42 (10.67)	332.80 (3,834.27)	5.5 (98.22)	137 (157.84)	5,557.59 (1,626,371.32)
28-18	5,300 (598.82)	8,000 (903.88)	.625 (15.88)	5,800	1,313.3 (595.70)	116,351 (3,404.89)	.65 (16.51)	736.85 (8,489.43)	8.8 (157.15)	332 (382.51)	13,507.52 (3,952,836.23)
34-15	6,000 (677.91)	15,000 (1,694.77)	.875 (22.23)	5,000	2,131.1 (966.65)	256,172 (7,496.61)	.41 (10.41)	1,147.57 (13,221.44)	13.1 (233.94)	754 (868.70)	30,650.07 (8,969,426.46)

- ① All ratings at .25° misalignment. Higher misalignments available; consult Ameridrives.
- ② Higher speeds available. Consult Ameridrives for torque capacities at higher than rated speed.
- ③ Weight, WR² and KT based on J=18 inch SH-SH (457.2mm or minimum SH-SH, whichever is greater), and nominal bores.
- ④ Peak torque rating is at maximum axial travel rating.

Dimensions inches (mm)

Coupling Size	Coupling O.D. A	Barrel Dia. B Max.	Flange Dia. C	Spacer I.D. D	Spacer O.D. E	Bore Dia. F Nominal	Bore Dia. F Max.	Shaft Length G	Shaft-to-Shaft J Min.	⑤ Coupling Length L	Stiffness per Diaphragm 6	
											Axial Stiffness Lb.In. (N/mm)	Bending Stiffness In.Lb./Degree (Nm/Degree)
5	5.97 (151.64)	4.56 (115.82)	4.00 (101.60)	2.44 (61.98)	2.69 (68.33)	2.00 (50.80)	3.25 (82.55)	2.44 (61.98)	7.38 (187.45)	22.88 (581.15)	800 (140)	70 (8)
6	6.94 (176.28)	5.44 (138.18)	4.88 (123.95)	2.94 (74.68)	3.25 (82.55)	2.50 (63.50)	3.75 (95.25)	3.03 (76.96)	8.00 (203.20)	24.06 (611.12)	700 (123)	72 (8)
8	8.97 (227.84)	7.25 (184.15)	5.62 (142.75)	3.44 (87.38)	4.00 (101.60)	3.50 (88.90)	5.00 (127.00)	4.19 (106.43)	9.88 (250.95)	26.38 (670.05)	1,100 (193)	228 (26)
10	10.94 (277.88)	8.50 (215.90)	7.38 (187.45)	5.00 (127.00)	5.50 (139.70)	4.00 (101.60)	6.00 (152.40)	4.75 (120.65)	11.12 (282.45)	27.50 (698.50)	1,000 (175)	233 (26)
12	12.94 (328.68)	10.62 (269.75)	8.25 (209.55)	5.44 (138.18)	6.13 (155.70)	5.00 (127.00)	7.50 (190.50)	6.03 (153.16)	13.19 (335.03)	30.06 (763.52)	1,500 (263)	643 (73)
14	14.75 (374.65)	12.12 (307.85)	9.25 (234.95)	6.25 (158.75)	6.94 (176.28)	5.50 (139.70)	8.50 (215.90)	6.03 (153.16)	14.50 (368.30)	30.06 (763.52)	1,400 (245)	650 (73)
16	16.94 (430.28)	14.00 (355.60)	11.25 (285.75)	7.06 (179.32)	7.81 (198.37)	6.00 (152.40)	10.00 (254.00)	7.22 (183.39)	16.56 (420.62)	32.44 (823.98)	3,000 (525)	2,250 (254)
19	19.88 (504.95)	16.00 (406.40)	12.19 (309.63)	7.31 (185.67)	8.50 (215.90)	7.00 (177.80)	11.25 (285.75)	8.69 (220.73)	19.75 (501.65)	37.13 (943.10)	2,700 (473)	2,240 (253)
22	22.88 (581.15)	18.88 (479.55)	14.12 (358.65)	9.31 (236.47)	10.56 (268.22)	9.00 (228.60)	13.50 (342.90)	10.88 (276.35)	20.50 (520.70)	42.26 (1,073.40)	2,500 (438)	2,300 (260)
28	29.00 (736.60)	23.00 (584.20)	18.50 (469.90)	11.44 (290.58)	13.06 (331.72)	12.00 (304.80)	16.25 (412.75)	13.88 (352.55)	25.50 (647.70)	53.26 (1,352.80)	2,300 (403)	2,417 (273)
34	34.44 (874.78)	29.50 (749.30)	22.00 (558.80)	14.19 (360.43)	16.13 (409.70)	14.00 (355.60)	21.00 (533.40)	16.00 (406.40)	34.50 (876.30)	66.50 (1,689.10)	2,500 (438)	7,308 (826)

⑤ Coupling length based on J = 18 inch SH-SH (457.2mm or minimum SH-SH, whichever is greater).

⑥ Coupling Axial Stiffness lb.in. (N/mm) = $\frac{\text{No. of Diaphragms}}{2}$ x Diaphragm Axial Stiffness.

Coupling Bending Stiffness in.lb. (Nm)/Degree = No. of Diaphragms x Diaphragm Bending Stiffness.

Balance

Ameriflex couplings are designed to achieve the low levels of potential unbalance necessary to meet the increasing demands of high performance equipment. Turbomachinery vibration levels can be dramatically affected by coupling unbalance.

All components are machined to stringent tolerances and balanced to the lowest possible levels of residual unbalance. The use of light interference fits allows Ameriflex couplings to be repeatably assembled without changing component mass eccentricities which helps maintain superior levels of balance.

All Ameriflex components and assemblies are balanced to the residual unbalance levels of API-671. All rigid hubs, subassemblies, and other short components are single plane balanced. Spacers and complete couplings are two plane balanced. All balancing is done on precise soft bearing balancing equipment, with the latest advancements in modern computer technologies.

Fasteners are weight balanced in sets to API-671 standards. Component balanced parts of a coupling assembly are interchangeable with new parts from identical couplings. Trim balance holes are provided on request. Major components are matchmarked for identical reassembly.

Ameriflex couplings can be provided complying to any API-671 balance option. In addition, any options for residual unbalance check or balance machine sensitivity check can be provided. For non-API couplings, component balancing will be provided unless otherwise specified.

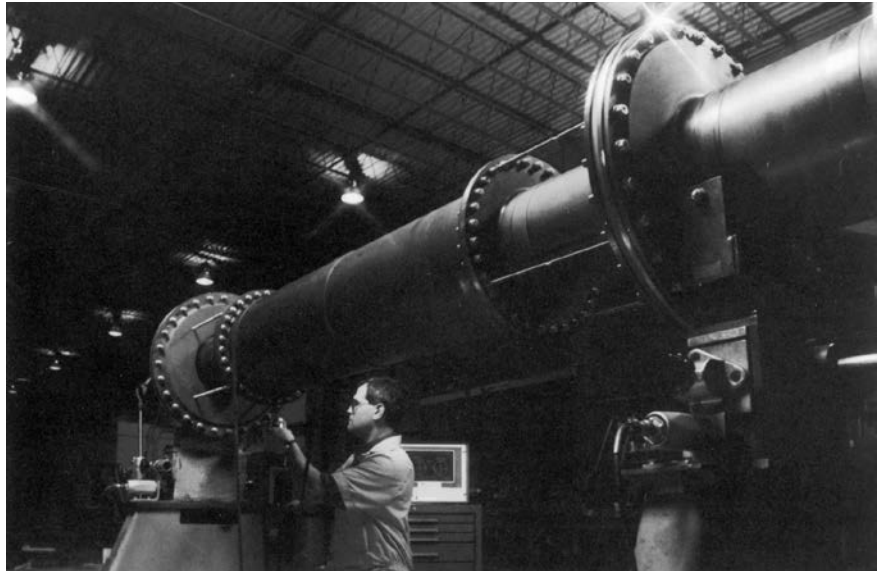

Assembly balancing of a S23-10 Ameriflex coupling for the LM-6000 gas turbine

Speed Limits

Speed Limits

Diaphragm couplings are an integral part of a system. If a system is very rigid then the maximum speed might be increased. If the system is soft and has a long shaft overhang, then it may be necessary to decrease speed limits. Whenever possible, a detailed system lateral critical speed analysis should be performed by the user. Ameridrives recommends the coupling lateral critical speed be a minimum of 1.5 times the maximum continuous operating speed.

Axial Natural Frequency - (ANF)

Metallic membrane couplings typically rely on deformation of the membrane to

accommodate angular and axial misalignment between the shaft ends of the mating equipment. This deformation is accompanied by a resultant force attempting to restore the membrane to its undeformed shape. Under certain conditions, the coupling may resonate along the axis of rotation in what is commonly referred to as the coupling's axial natural frequency (ANF).

Inherent in the design and characteristics of metallic membrane couplings is the deformation and stiffness when axially deflected. For small deflections this stiffness is constant for any type of

membrane coupling. As deflections become increasingly larger, this stiffness may remain constant or may become increasingly non-linear, depending upon the design of the coupling. Forces that are generated from this stiffness must be counteracted by the thrust bearings.

As a coupling rotates, there may be axial excitations such as runout in a thrust bearing. This may introduce a resonance in the coupling where the weight supported by the membranes axially vibrates at the ANF. This resonance is dependent on the magnitude of the axial excitation and any inherent damping that may be present throughout the train. It is very difficult to predict if a system will have a significant excitation, what the coupling response will be, and if this response is detrimental to the coupling itself.

Any coupling resonating at an ANF will have additional cyclic axial stress which could affect the life of the coupling. Additionally, microscopic motion from frictional damping between adjacent laminations in non-separated metallic membranes, such as disc type couplings, can accelerate wear. The Ameriflex coupling design provides separation of the flex area which prevents wear and provides a single ANF.

For these reasons, it is best to avoid operating a coupling at its ANF. Ameridrives standard practice is to avoid an ANF at 20% away from the operating speed. The existence of any axial excitations should be noted when inquiring about a metallic membrane coupling.

Retrofit Applications

When any High Performance coupling is selected to replace another type of coupling (Example: Diaphragm replacing Class I Gear or a competitor's coupling), it is recommended that a complete system analysis be done by the purchaser. This is necessary since many equipment manufacturers use couplings for tuning their systems. Therefore, indiscriminately changing a coupling may result in movement of a torsional or lateral critical into the operating speed range.

When designing Ameriflex Couplings for retrofit applications, we attempt to match the weight, torsional stiffness, and overhung moment characteristics of the existing coupling. To properly select a coupling, the following information is required:

1. A drawing of the existing coupling providing the following data:
 - a. Weight
 - b. Torsional Stiffness
 - c. Polar moment of inertia (WR^2)
 - d. Centers of gravity
 - e. Axial and bending stiffness for disc or diaphragm couplings
 - f. Distance from journal bearing centerline to end of shaft
 - g. Thermal growth
2. A drawing of the existing coupling guard
3. History of the existing coupling.
 - a. Length of time in service
 - b. Any problems experienced

NOTE: Couplings are selected based on information supplied by the purchaser. Ameridrives will not be responsible for errors due to incomplete or inaccurate information. The application of the guidelines above are not a guarantee of the successful operation of any coupling in any system. It is the responsibility of the purchaser to take the coupling characteristics and determine their effect on the system.

For assistance in selection, fill out and return pages 22 and 23 with your specific application requirements, including additional retrofit information.

Various and Custom Applications

Custom Applications

Integral filler diaphragms can be customized for special applications. The outside diameter holes can be customized to bolt directly to the customer's flanged shaft. The diaphragm thickness in the flex area and the number of diaphragms can be optimized to meet an application's given stiffness and torque requirements.

The custom designed coupling can have a higher torque capacity or greater misalignment capability and can meet the special requirements of turbomachinery in petrochemical and power generation applications.

Consult Ameridrives for information on your custom application.

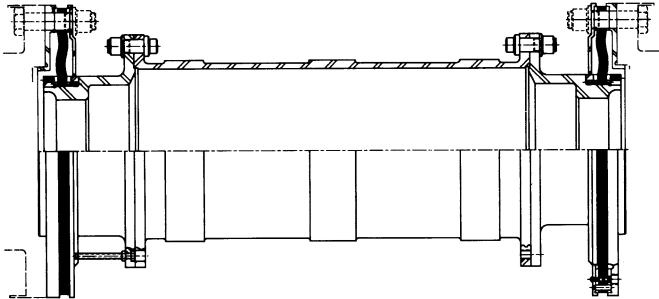

#S19-12 Frame 6000 Load Coupling

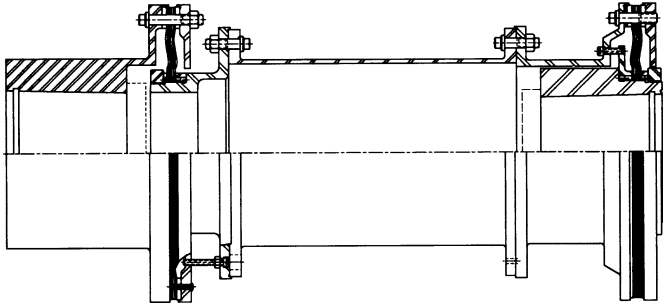

RR/RM Split Series

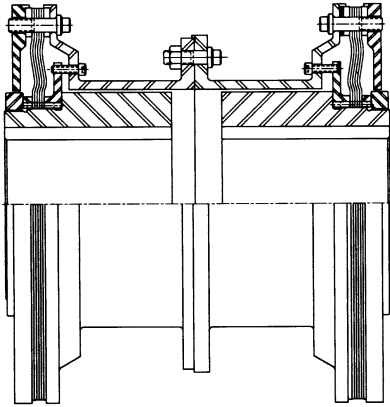

Close Coupled RM Series with Helicoils

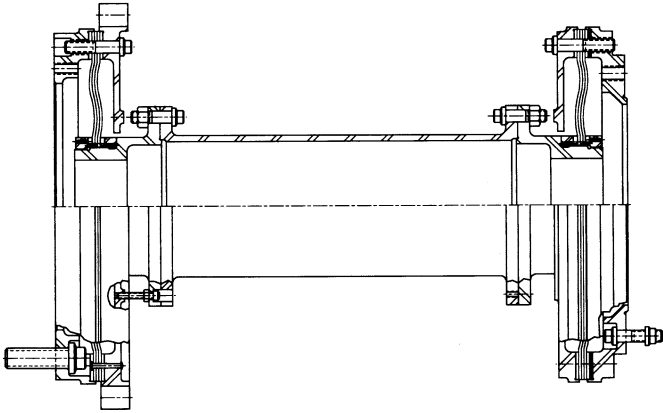

#S14-4 Frame 6000 Accessory Coupling

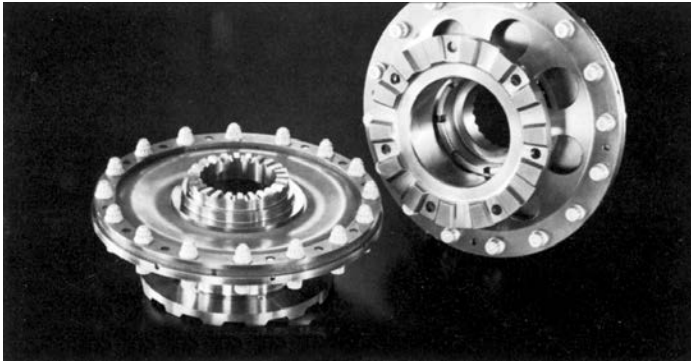

V22 Osprey Interconnect Drive System - Special #6-8



#12-8 RR with Torquemeter Spacer

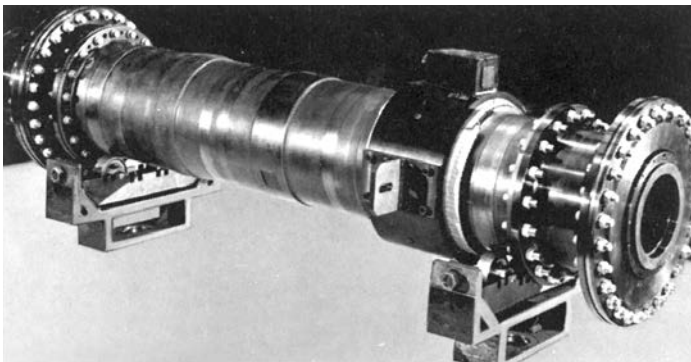

#14-8 RR/RM with Torquemeter



#S22-9 LM2500

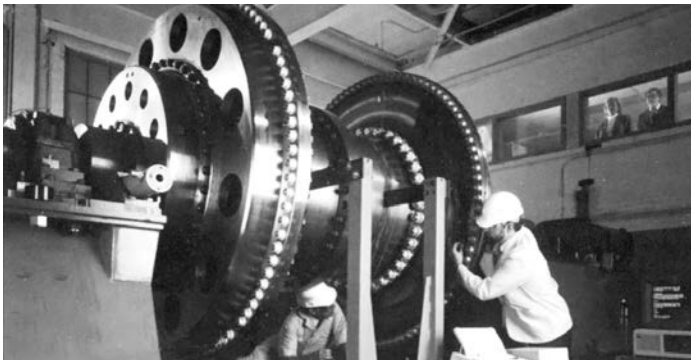

#80-7 on Test Stand



#14-10 16-6 RR/RM Split Size/Series

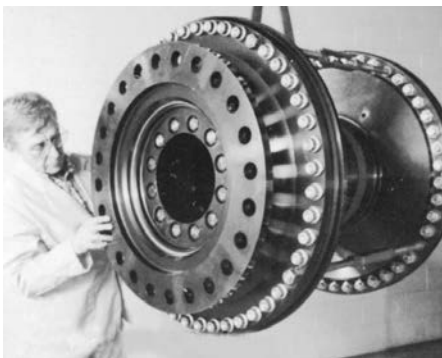

#34-11 HP Short Design



#S23-10 LM 6000

Application Data



Customer: _____ Inquiry No.: _____
Date: _____ No. of Pages: _____ (including cover sheet) Phone: _____
No. of Units: _____ Fax: _____

Ameriflex Coupling Information Requirements for Selection and Design

Application _____
Description of drive and driven equipment _____

Operating Conditions

Normal HP (Kw) _____ Maximum Continuous HP _____
Speed (RPM) Min _____ Dwell _____ Normal (Rated) _____ Max _____ Trip _____
Torque in.-Lb. (Nm) Continuous _____ Max Transient _____
Service Factor Required _____
Anticipated Misalignment _____
Steady State Angular _____ Offset _____ Axial _____
Transient Angular _____ Offset _____ Axial _____

Shaft Information (Interface Connection)

	Driver	Driven
Type (Flange, Cylindrical, Etc.)	_____	_____
Bore Diameter and Type (Hydraulic, Straight, Etc.)	_____	_____
Amount of Interference (Min/Max)	_____	_____
Keyway Dimensions and Quantity	_____	_____
Puller Holes (Size, Quantity, Location)	_____	_____
Width and Diameter of Locknuts (if applicable) (see page 23)	_____	_____

Miscellaneous Information

Shaft-to-shaft _____
Desired Pre-stretch _____
Electrical Insulation Requirements Yes _____ No _____
Is API-671 or Other Specification Applicable? _____
Unusual Atmospheric Conditions such as Chlorine, H₂S, Etc. _____
Envelope Restrictions _____
Additional Information that you feel may be Pertinent: _____

Tapered Shaft Applications

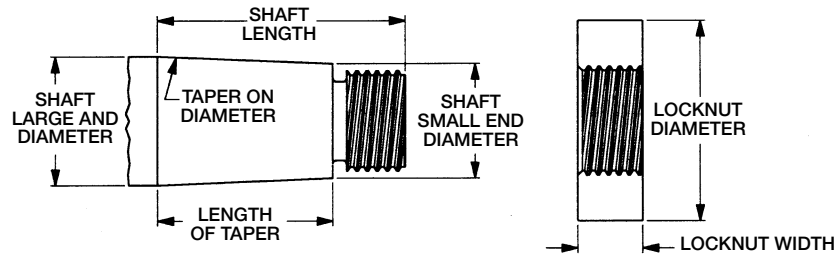

Shaft Data	Drive Data	Driven End
Shaft Large End Diameter		
Shaft Small End Diameter		
Length of Taper		
Shaft Length		
Taper (in/ft) on Diameter		
Locknut Diameter		
Locknut Width		

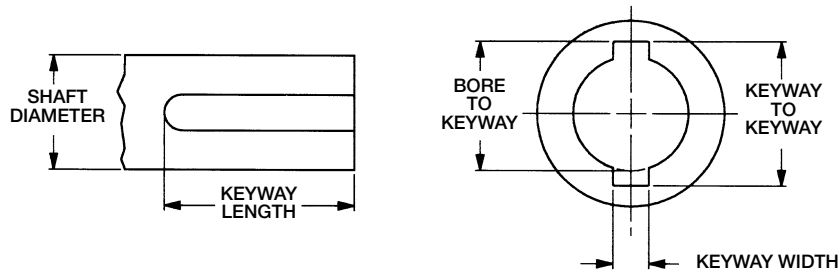

Shaft Data	Drive Data	Driven End
Shaft Large End Diameter		
Shaft Small End Diameter		
Length of Taper		
Shaft Length		
Taper (in/ft) on Diameter		
Locknut Diameter		
Locknut Width		

This product will be selected based on the information supplied to Ameridrives by the Purchaser. Complete and accurate information will help to minimize errors and misapplications. Further, it is the responsibility of the Purchaser to assure the interface connection between couplings and connected equipment (flanges, bolting, keys, hydraulic fits, etc.), are capable of handling anticipated loads. Ameridrives will not be responsible for errors due to inaccurate or incomplete information supplied to Ameridrives nor does Ameridrives assume responsibility of the interface connection.

For further information and installation procedures, contact Ameridrives Couplings.

Ameridrives Facilities

North America

USA

1802 Pittsburgh Avenue
Erie, PA 16502 - USA
814-480-5000

*Mill Spindles, Ameriflex, Ameridisc,
Universal Joints, Driveshafts,
Mill Gear Couplings*

2000 Clovis Barker Road
San Marcos, TX 78666 - USA
888-449-9439

*Gear Couplings, Small Industrial
Driveshafts*

300 Indiana Highway 212
Michigan City, IN 46360
219-874-5248

Irrigation Universal Driveshafts



**Scan to see all
the brands of
Regal Rexnord**

Neither the accuracy nor completeness of the information contained in this publication is guaranteed by the company and may be subject to change in its sole discretion. The operating and performance characteristics of these products may vary depending on the application, installation, operating conditions and environmental factors. The company's terms and conditions of sale can be viewed at <http://www.altramotion.com/terms-and-conditions/sales-terms-and-conditions>. These terms and conditions apply to any person who may buy, acquire or use a product referred to herein, including any person who buys from a licensed distributor of these branded products.

©2023 by Ameridrives LLC. All rights reserved. All trademarks in this publication are the sole and exclusive property of Ameridrives LLC or one of its affiliated companies.

