

CFW500-IP20-G2 (GENERATION-2) VARIABLE SPEED DRIVE

High performance and reliability to
improve your production process



Motors | Automation | Energy | Transmission & Distribution | Coatings

CFW500

Machinery Drive

Endless possibilities

The CFW500 2nd Generation or G2 has the same advanced technology, plug and play options, as before and the new generation has even more to offer. The new generation of CFW500 can be commissioned quickly, offers competitive advantage, excellent performance and reliability. Designed for industrial and professional use, it is perfect for OEM, system integrators, panel installers, and end users providing great benefit from the added value.



High performance

Optional version with integrated safety functions

Wide power range and high overload capacity

High performance control methods



Flexible

Connectivity

Advanced resources and functions

Assembly options



Robust

Version with IP20 & IP66 /NEMA4X



Innovative

SoftPLC - built-in PLC functionalities

Free programming software



Reliable

WEG Quality

Protection against ground fault, short circuit, over temperature and others

Optional, Internal RFI filter to reduce high-frequency electromagnetic interference



Integrated STO (Safe Torque Off) and SS1 (Safe Stop 1) fulfils requirements for safety performance SIL 3 / PL e, according to IEC 61800-5-2, EN ISO 13849-1, EN 62061, IEC 61508 and IEC 60204-1

Provides machine builders a cost-effective solution to design protective measures to reduce the risk from unexpected and hazardous movement in industrial machines

Models from 1,0 to 105 A (0,25 kW / 0,33 HP to 55 kW / 75 HP) at supply voltages 200-240, 380-480 or 500-600 V

Permits the CFW500 to be used in a large variety of applications, improving their overall performance

Sensorless or closed loop vector control, VVW or Scalar V/f and permanent magnet motor control: VVW PM

USB and fieldbus communication modules for the most used industrial networks, like CANopen, DeviceNet, Profibus-DP, EtherNet/IP, PROFINET IO or Modbus-RTU

Full integration with process network

Pump Genius software

Dedicated functions ideal for pumping systems

Surface or DIN rail mounting, including side-by-side installation

Saves space and cabling, reducing installation costs

Complete protection against contact with internal live parts, avoiding the entrance of dust or water coming from jets

The high protection degree dispenses the panel, reducing installation costs

The VFD, motor and application can work in an interactive way, because it is possible to make customized logic and applications.

Ideal for machinery manufacturer

WLP, WPS and SuperDrive G2 software available at www.weg.net

100% of the VFDs are tested at the factory under full load and maximum temperature

High reliability

Conformal Coating as standard, class 3C2 according to IEC 60721-3-3 and 3C3 as an option, to protect against corrosive gases in harsh environments

VFD lifetime is extended

It prevents damage to the inverter which can be caused by adverse situations, normally external factors.

Certifications



Flexibility and Performance

The CFW500 has a modern design and it can be selected according to the application requirements, providing flexibility with excellent performance. The VSD gives the user the possibility to choose the plug-in module that best fits his application, or to use the standard version, that comes with the CFW500-IOS plug-in module. All plug-in modules comes with one RS485 port as standard.

The installation of the CFW500 is simple and its configuration and operation is intuitive with the navigation menus of the operating interface (HMI) with built-in LCD display. By using the flash memory module, it is possible to download the existing setting from one CFW500 to other units without powering them up.

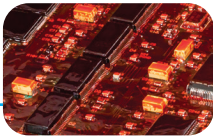

Conformal Coating

Improved 3C2 class of coating on the internal circuits of all versions and extra 3C3 Class coating (optional) according to IEC 60721-3-3 ensures improved protection in environments with corrosive chemicals.

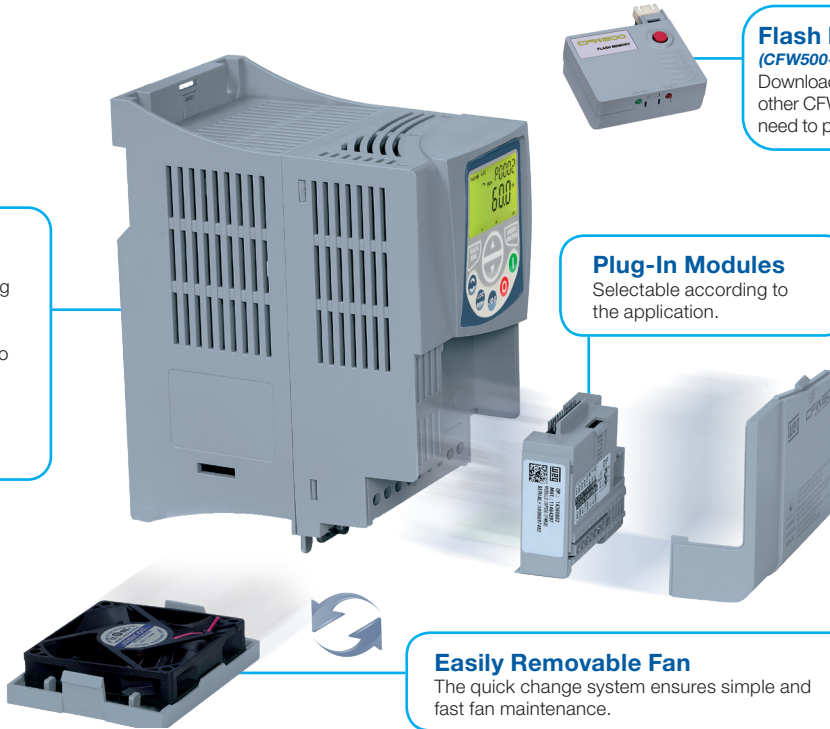

Flash Memory Module

(CFW500-MMF Accessory)

Download/Upload the settings to other CFW500 units without the need to power them up.

Plug-In Modules

Selectable according to the application.

Easily Removable Fan

The quick change system ensures simple and fast fan maintenance.



SoftPLC

It is a software resource added to the CFW500 which allows the user to implement and debug logic projects equivalent to a small PLC (Programmable Logic Controller), customizing and integrating the CFW500 to the application. The free WPS/WPL programming software is available at: www.weg.net.

Connectivity



Remote operating interface (HMI) (CFW500-HMIR accessory)



USB Connection (CFW500-CUSB accessory)

The CFW500 can be connected to the main fast industrial Fieldbus communication networks, with protocols used worldwide such as CANopen, Profibus-DP, DeviceNet, PROFINET IO, EtherNet/IP and Modbus-TCP, according to the plug-in module selected.

In addition, all plug-in modules come with serial interface RS485 Modbus-RTU built-in.

Easy operation and view



Free at www.weg.net

SuperDrive G2

- I/O expansion:
 - IOS (standard, included in the version with plug-in), IOD, IOAD, IOR
- Functionality expansion:
 - Incremental encoder
 - USB
- Fieldbus communication protocols:
 - CANopen
 - DeviceNet
 - RS232
 - RS485
 - Profibus-DP
 - EtherNet/IP
 - Modbus-TCP
 - PROFINET IO

Selectable plug-in modules

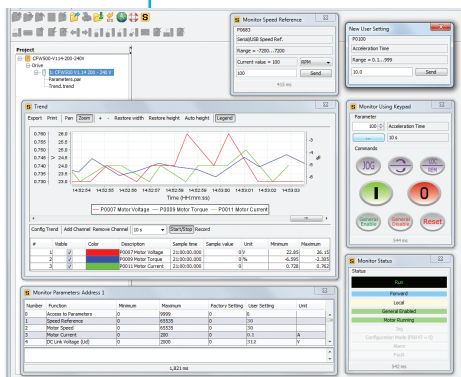

Using the SuperDrive G2 software, it is possible to change, monitor and view graphically the variables of the CFW500 on a personal computer.

Trend Function
Trend charts for online monitoring of parameters and other variables within the SuperDrive G2 software.

Features

- Special engineering units (RPM, °C, Nm, mA, %, kW, kWh, among others)
- Password to protect the parameters
- Backup of all parameters (via SuperDrive G2 software, or plugin memory MMF)
- Possibility to save up to two different settings on the memory of the CFW500
- Setting of the switching frequency according to the application requirements
- Speed reference via electronic potentiometer
- Multispeed with up to eight programmable speeds
- Slip compensation
- Manual or automatic torque boost (V/F scalar mode) or self-adjustment (VVW and vector modes)
- Permanent magnet motor control: VVW PM
- Acceleration/deceleration ramps
- “S” type ramp
- DC braking
- Internal dynamic braking (except frame size A)
- PID controller to control processes in closed loop
- Flying start / Ride-through
- Sleep mode
- Skip frequencies or frequency ranges function adjustable
- Overload and overtemperature protection
- Overcurrent protection
- DC link voltage supervision
- Fault log
- Safety functions: STO and SS1



Human-Machine Interface (keypad)

- Display up to three variables at the same time, selected by the user

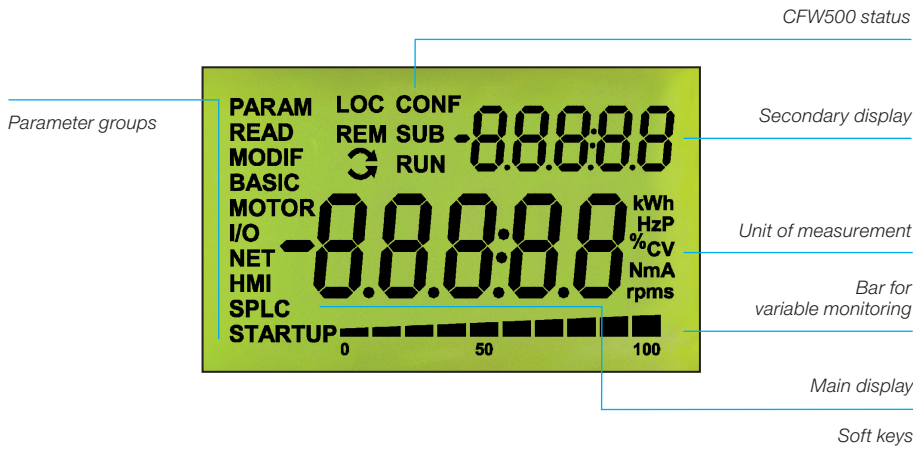

Friendly Programming

- Oriented start-up: programming step by step
- Easy and intuitive operation, fast access to the parameters
- Parameter group: shortcut to the parameters of interest

Remote HMI (keypad)

Suitable for enclosure door or machine console, two options available.



RS485
Included in all plug-in modules

CFW500-HMIR
Non-Text Remote Keypad



CFW500-CCHMIRXM
X = up to 10 m

HMI-01
Advanced Text Remote Keypad



Embedded Safety Functions - with optional Module, CFW500-SFY2

Used to reduce risk and to guarantee the safety of personnel and environment if there is a hazardous event due to a fault in operating machines. The embedded safety functions **STO** and **SS1** provide machine builders a cost-effective solution to design protective measures and reduce the risk from unexpected and hazardous movement in industrial machines and processes.

Advantages

- Safety functions integrated in the CFW500 drive, making easier to comply with the machine and application safety requirements
- Less components, no need for additional wiring, saving space and installation costs
- Easier installation, commissioning and maintenance
- No electromechanical components, meaning faster responses and higher degree of productivity
- Due to the high safety performance level SIL3, the CFW500 with Safety module may avoid the use of external safety relays for cables and emergency pushbuttons monitoring



Safety Functions

STO (Safe Torque Off)

This function immediately switches off the drive output to the motor, disabling the supply of torque-generating energy. STO is also used to prevent an unexpected startup of machinery or for an emergency stop, fulfilling stop category 0 (IEC 60204-1).

It is applicable if the motor can be brought to a standstill in a sufficiently short time by the load torque or friction or where motor coast to a stop is not relevant to safety.

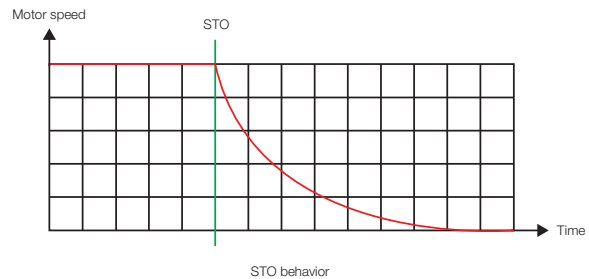

SS1 (Safe Stop 1)

This function enables motor deceleration and then, after a delay time, activates the STO function. SS1 can be used to implement a controlled stop and then removal of power, fulfilling stop category 1 according to IEC 60204-1. This function is used when, in the event of a safety related fault, the drive must stop as quickly as possible and then enter the STO state.

The stopping of a drive by means of SS1 function reduces the risk of danger, eliminates the need of external safety timers, increases the productivity of a machine and allows safety clearances in a machine to be reduced. The reason is the active stopping of the drive as compared with the use of the STO function only.

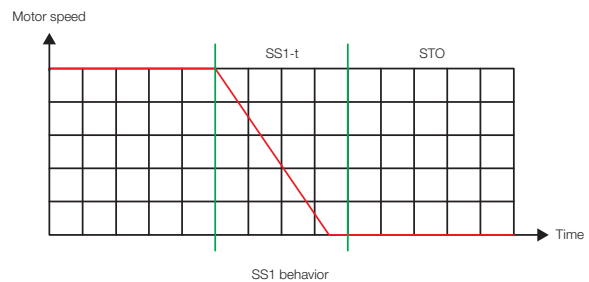

Pump Genius

The Pump Genius is a customizable feature of WEG drives that enables your standard CFW500 to become dedicated for pumping systems. It ensures accurate pressure / flow control throughout the processing cycle, starting with raw water and its usage, ending on wastewater treatment. With an easy-to-use programming wizard, Pump Genius helps you to minimize downtime and maximize energy savings. Everything you need is selecting one option that best fits your application:

simplex

The Pump Genius Simplex software adds ideal features to the VFD for single pump control.

multipump

Pump Genius Multipump allows driving two or more pumps with only one inverter.

multiplex

Pump Genius Multiplex permits the VFDs to control, monitor and manage the entire system on their own, eliminating the need of external PLC.

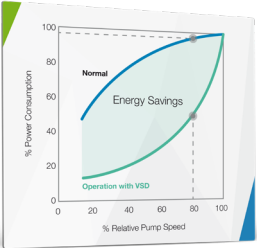

Energy Savings

The use of the CFW500 with the Pump Genius Multipump improves the performance and provides electric energy savings.

Using this solution together with WEG W22 Premium motors, and reducing the pump speed even if slightly, it is possible to reduce the electric energy consumption by approximately 15%, thus contributing to the sustainable development of the planet.



Broken Pipe Alarm

Pump Genius detects when the pump is consuming more electric energy than it should, by means of information on the pump load and speed, automatically generating an alarm warning of leaky pipes. In addition, with the monitoring of the system pressure, a clogging condition may be detected by configuring the maximum pressure to trigger the alarm of clogged pipe.

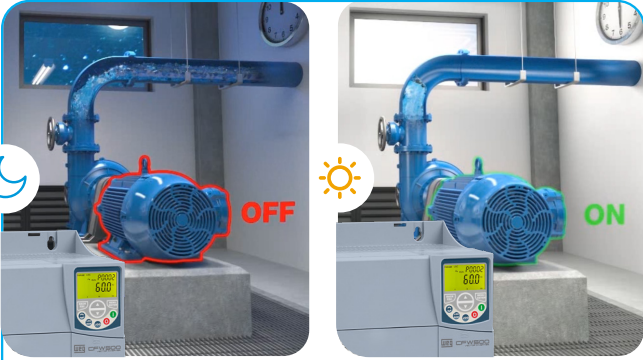

Sleep and Wake up Function

The sleep function keeps the pump in the standby mode when the demand or flow is below the minimum, avoiding that it runs at low speed for long periods, providing electric energy savings and increasing the lifetime of the pump. The wake up function restarts the drive automatically when the pressure falls below the set point.

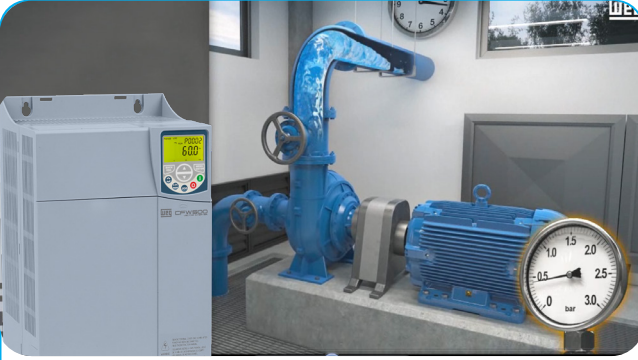

Pipe Charging Function

It allows lubrication and smooth initial charging of the pipes, making the pump operate at a lower preset speed for a certain time, avoiding "Water Hammers", which may damage the piping system.

Applications

Extruders



Conveyor belts



Roller tables



Fans / exhausters



Centrifugal pumps



Granulators / palletizers



Cutting and welding machines

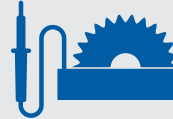

Dryers and rotary ovens



Process dosing pumps



Stirrers / mixers



Rotary filters



Winding machines / uncoiling machines

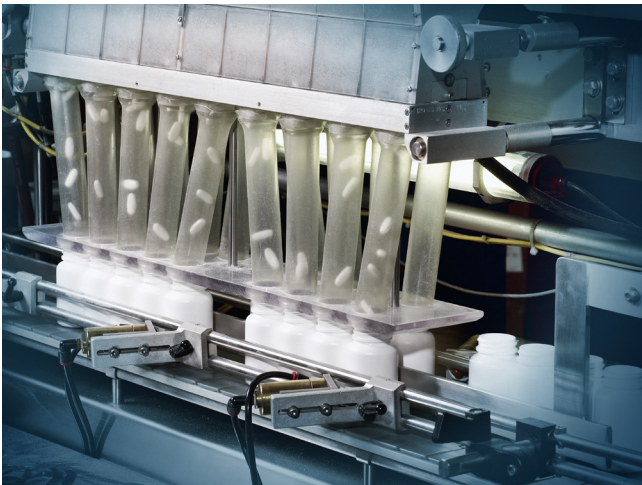
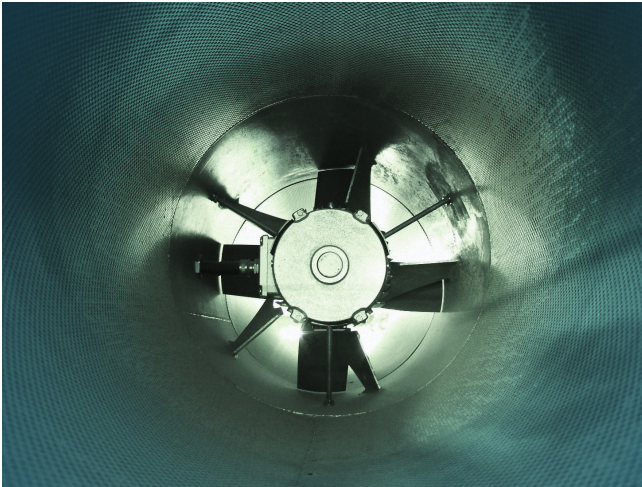
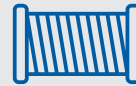

Product Coding

The CFW500 code identifies its construction characteristics, nominal current, voltage range and optionals. Using the product code, it is possible to select the CFW500 required for your application simply and quickly.

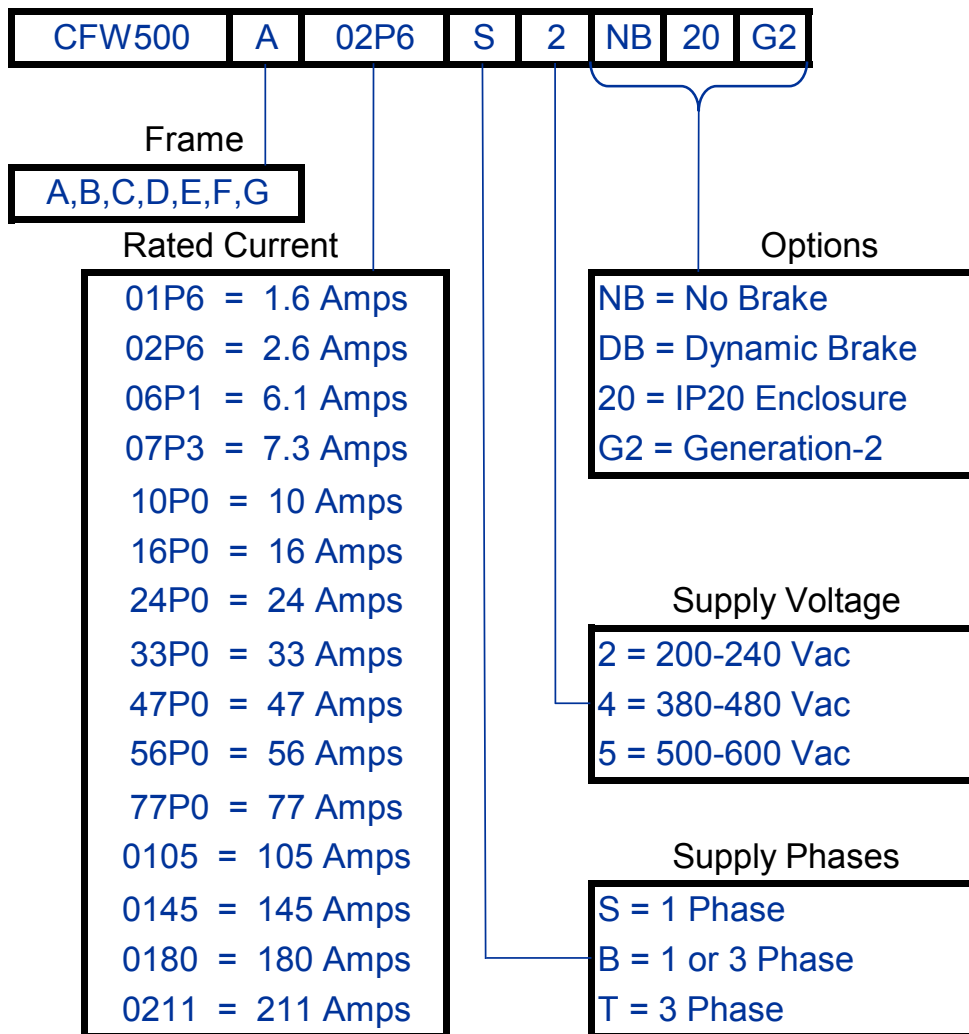

CFW500-IP20-G2 Drives Rating

The correct way to select a VFD is matching its output current with the motor rated current. However, the tables below present the approximate motor power for each VFD model. Use the motor power ratings below only as a guide. Motor rated currents may vary with speed and manufacturer.

3 Phase / 230VAC Motor Voltage

ND / VT ¹		HD / CT ¹		Catalog Number	Braking Transistor	Frame Size ⁴	Dimensions (in.) HxWxD	Approx. Weight (lbs.)
Motor HP ²	Drive Amps ³	Motor HP ²	Drive Amps ³					
Input power supply: Single-Phase 200 - 240 V								
1/3	1.6	1/3	1.6	CFW500A01P6S2NB20G2	No	A	7.5 x 3.0 x 5.9	1.8
3/4	2.6	3/4	2.6	CFW500A02P6S2NB20G2	No	A	7.5 x 3.0 x 5.9	1.8
1 1/2	4.3	1 1/2	4.3	CFW500A04P3S2NB20G2	No	A	7.5 x 3.0 x 5.9	1.8
2	7.3	2	7.3	CFW500A07P0S2NB20G2	No	A	7.5 x 3.0 x 5.9	1.8
Input power supply: Single or Three-Phase 200 - 240 V								
1/3	1.6	1/3	1.6	CFW500A01P6B2NB20G2	No	A	7.5 x 3.0 x 5.9	1.8
3/4	2.6	3/4	2.6	CFW500A02P6B2NB20G2	No	A	7.5 x 3.0 x 5.9	1.8
1 1/2	4.3	1 1/2	4.3	CFW500A04P3B2NB20G2	No	A	7.5 x 3.0 x 5.9	1.8
2	7.3	2	7.3	CFW500B07P3B2DB20G2	Yes	B	7.9 x 4.0 x 6.3	2.6
3	10.0	3	10.0	CFW500B10P0B2DB20G2	Yes	B	7.9 x 4.0 x 6.3	2.6
Input power supply: Three-phase 200 - 240 V								
2	7.0	2	7.0	CFW500A07P0T2NB20G2	No	A	7.5 x 3.0 x 5.9	1.8
3	9.6	3	9.6	CFW500A09P6T2NB20G2	No	A	7.5 x 3.0 x 5.9	1.8
5	16	5	16	CFW500B16P0T2DB20G2	Yes	B	7.9 x 4.0 x 6.3	2.6
7 1/2	24	7 1/2	24	CFW500C24P0T2DB20G2	Yes	C	8.3 x 5.3 x 6.5	4.4
10	28	10	28	CFW500D28P0T2DB20G2	Yes	D	12.1 x 7.1 x 6.6	9.5
10	33	10	33	CFW500D33P0T2DB20G2	Yes	D	12.1 x 7.1 x 6.6	9.5
15	47	15	47	CFW500D47P0T2DB20G2	Yes	D	12.1 x 7.1 x 6.6	9.5
20	56	20	56	CFW500E56P0T2DB20G2	Yes	E	13.8 x 8.7 x 7.6	22.1
25	77	20	64	CFW500F77P0T2DB20G2	Yes	F	21.6 x 11.8 x 10	57.3
30	88	25	75	CFW500F88P0T2DB20G2	Yes	F	21.6 x 11.8 x 10	57.3
40	105	30	88	CFW500F0105T2DB20G2	Yes	F	21.6 x 11.8 x 10	57.3
50	145	40	115	CFW500G0145T2NB20G2	No	G	26.6 x 13.2 x 12.4	114.6
60	180	50	145	CFW500G0180T2NB20G2	No	G	26.6 x 13.2 x 12.4	114.6
75	211	60	180	CFW500G0211T2NB20G2	No	G	26.6 x 13.2 x 12.4	114.6
50	145	40	115	CFW500G0145T2DB20G2	Yes	G	26.6 x 13.2 x 12.4	114.6
60	180	50	145	CFW500G0180T2DB20G2	Yes	G	26.6 x 13.2 x 12.4	114.6
75	211	60	180	CFW500G0211T2DB20G2	Yes	G	26.6 x 13.2 x 12.4	114.6

Notes:

- 1) ND (Normal Duty) / VT (Variable Torque): 110% Overload / 60 Sec;
HD (Heavy Duty) / CT (Constant Torque): 150% Overload / 60 Sec;
- 2) "HP" rating based on WEG W22 motors "average FLA values". Use as a guide only.
- 3) Motor FLA may vary with speed and manufacturer. ALWAYS compare motor FLA to Nominal AMPS of drive.
- 4) Frame Size A to E are rated for 50°C; Frame Size-F is rated for 40°C; Frame Size-G is rated for 45°C.
CFW500 Frame-F & G VFDs have built in Dual DC bus chokes.

CFW500-IP20-G2 Drives Rating

The correct way to select a VFD is matching its output current with the motor rated current. However, the tables below present the approximate motor power for each VFD model. Use the motor power ratings below only as a guide. Motor rated currents may vary with speed and manufacturer.

3 Phase / 460VAC Motor Voltage

ND / VT ¹		HD / CT ¹		Catalog Number	Braking Transistor	Frame Size ⁴	Dimensions (in.) HxWxD	Approx. Weight (lbs.)
Motor HP ²	Drive Amps ³	Motor HP ²	Drive Amps ³					
Input Power Supply: Three-Phase 380-480 Vac								
1/2	1.0	1/2	1.0	CFW500A01P0T4NB20G2	No	A	7.5 x 3.0 x 5.9	1.8
1	1.6	1	1.6	CFW500A01P6T4NB20G2	No	A	7.5 x 3.0 x 5.9	1.8
2	2.6	2	2.6	CFW500A02P6T4NB20G2	No	A	7.5 x 3.0 x 5.9	1.8
3	4.3	3	4.3	CFW500A04P3T4NB20G2	No	A	7.5 x 3.0 x 5.9	1.8
3	6.1	3	6.1	CFW500A06P1T4NB20G2	No	A	7.5 x 3.0 x 5.9	1.8
2	2.6	2	2.6	CFW500B02P6T4DB20G2	Yes	B	7.9 x 4.0 x 6.3	2.6
3	4.3	3	4.3	CFW500B04P3T4DB20G2	Yes	B	7.9 x 4.0 x 6.3	2.6
5	6.5	5	6.5	CFW500B06P5T4DB20G2	Yes	B	7.9 x 4.0 x 6.3	2.6
7 1/2	10	7 1/2	10	CFW500B10P0T4DB20G2	Yes	B	7.9 x 4.0 x 6.3	2.6
10	14	10	14	CFW500C14P0T4DB20G2	Yes	C	8.3 x 5.3 x 6.5	4.4
10	16	10	16	CFW500C16P0T4DB20G2	Yes	C	8.3 x 5.3 x 6.5	4.4
15	24	15	24	CFW500D24P0T4DB20G2	Yes	D	12.1 x 7.1 x 6.6	9.5
25	31	25	31	CFW500D31P0T4DB20G2	Yes	D	12.1 x 7.1 x 6.6	9.5
30	39	30	39	CFW500E39P0T4DB20G2	Yes	E	13.8 x 8.7 x 7.6	22.1
40	49	40	49	CFW500E49P0T4DB20G2	Yes	E	13.8 x 8.7 x 7.6	22.1
60	77	50	61	CFW500F77P0T4DB20G2	Yes	F	21.6 x 11.8 x 10	57.3
75	88	60	73	CFW500F88P0T4DB20G2	Yes	F	21.6 x 11.8 x 10	57.3
75	105	75	88	CFW500F105T4DB20G2	Yes	F	21.6 x 11.8 x 10	57.3
125	142	100	115	CFW500G0142T4NB20G2	No	G	26.6 x 13.2 x 12.4	114.6
150	180	125	142	CFW500G0180T4NB20G2	No	G	26.6 x 13.2 x 12.4	114.6
175	211	150	180	CFW500G0211T4NB20G2	No	G	26.6 x 13.2 x 12.4	114.6
125	142	100	115	CFW500G0142T4DB20G2	Yes	G	26.6 x 13.2 x 12.4	114.6
150	180	125	142	CFW500G0180T4DB20G2	Yes	G	26.6 x 13.2 x 12.4	114.6
175	211	150	180	CFW500G0211T4DB20G2	Yes	G	26.6 x 13.2 x 12.4	114.6

3 Phase / 575VAC Motor Voltage

ND / VT ¹		HD / CT ¹		Catalog Number	Braking Transistor	Frame Size ⁴	Dimensions (in.) HxWxD	Approx. Weight (lbs.)
Motor HP ²	Drive Amps ³	Motor HP ²	Drive Amps ³					
Input Power Supply: Three-Phase 500-600 Vac								
1 1/2	1.7	1 1/2	1.7	CFW500C01P7T5DB20	Yes	C	8.3 x 5.3 x 6.5	4.4
3	3.0	3	3.0	CFW500C03P0T5DB20	Yes	C	8.3 x 5.3 x 6.5	4.4
3	4.3	3	4.3	CFW500C04P3T5DB20	Yes	C	8.3 x 5.3 x 6.5	4.4
7 1/2	7.0	7 1/2	7.0	CFW500C07P0T5DB20	Yes	C	8.3 x 5.3 x 6.5	4.4
10	10.0	10	10.0	CFW500C10P0T5DB20	Yes	C	8.3 x 5.3 x 6.5	4.4
10	12.0	10	12.0	CFW500C12P0T5DB20	Yes	C	8.3 x 5.3 x 6.5	4.4

Notes:

- 1) ND (Normal Duty) / VT (Variable Torque): 110% Overload / 60 Sec;
HD (Heavy Duty) / CT (Constant Torque): 150% Overload / 60 Sec;
- 2) "HP" rating based on WEG W22 motors "average FLA values". Use as a guide only.
- 3) Motor FLA may vary with speed and manufacturer. ALWAYS compare motor FLA to Nominal AMPS of drive.
- 4) Frame Size A to E are rated for 50°C; Frame Size-F is rated for 40°C; Frame Size-G is rated for 45°C.
CFW500 Frame-F & G VFDs have built in Dual DC bus chokes.
- 5) All 575V drives are non-stocked items and are still Generation-1 drives, consult WEG for availability.

Accessories

Plug-In Module

The CFW500 comes with the IOS module included. Other modules are available to expand the inputs or outputs available as noted in the table below. Communication modules can be selected based on the monitoring or control network in use. RS-485 is included on the CFW500 as standard.

Reference	Description	Illustrative figures
Input and output (I/O) expansion		
CFW500-IOS ¹⁾	Standard plug-in module (included in the version with plug-in module)	
CFW500-IOD	Digital input and output (I/O) expansion plug-in module	
CFW500-IOAD	Digital and analog input and output (I/O) expansion plug-in module	
CFW500-IOR-B	Relay output expansion plug-in module	
Functionality expansion		
CFW500-SFY2	CFW500 Safety Function Module; Safe Torque Off (STO) / Stop Category 0, Safe Stop 1 Time Controlled (SS1-t) / Sop Category 1; Safety Category: SIL 3, PL e	
CFW500-ENC	Plug-in module with encoder input	
CFW500-CUSB	Plug-in module with USB port	
Communication on Fieldbus network		
CFW500-CCAN	CAN communication plug-in module (CANopen/DeviceNet)	
CFW500-CRS232	RS232 communication plug-in module	
CFW500-CRS485-B	RS485 communication plug-in module	
CFW500-CPDP	Profibus-DP communication plug-in module	
CFW500-CETH-IP	EtherNet/IP communication plug-in module	
CFW500-CEMB-TCP	Modbus-TCP communication plug-in module	
CFW500-CEPN-IO	PROFINET IO communication plug-in module	
Memory		
Interfaces		
Remote operating interface (HMI)		
CFW500-HMIR	CFW500 Remote Advanced Text Keypad for mounting through enclosure door (Mounting Frame Kit is required)	
HMI-01	CFW500 Remote Advanced Text Keypad enclosure door mounting frame kit	
CFW500-RHMIF	CFW500 Remote Advanced Text Keypad enclosure door mounting frame kit	
CFW500-CCHMIR1M	1-meter cable set for remote operating interface (HMI)	
CFW500-CCHMIR2M	2-meter cable set for remote operating interface (HMI)	
CFW500-CCHMIR3M	3-meter cable set for remote operating interface (HMI)	
CFW500-CCHMIR5M	5-meter cable set for remote operating interface (HMI)	
CFW500-CCHMIR75M	7.5-meter cable set for remote operating interface (HMI)	
CFW500-CCHMIR10M	10-meter cable set for remote operating interface (HMI)	
Description		
CFW500-KN1A	NEMA 1 Kit - size A (standard for option N1)	
CFW500-KN1B	NEMA 1 Kit - size B (standard for option N1)	
CFW500-KN1C	NEMA 1 Kit - size C (standard for option N1)	
CFW500-KN1D	NEMA 1 Kit - size D (standard for option N1)	
CFW500-KN1E	NEMA 1 Kit - size E (standard for option N1)	
CFW500-KN1F	NEMA 1 Kit - size F (standard for option N1)	
CFW500-KN1G	NEMA 1 Kit - size G (standard for option N1)	
CFW500-KPCSA	Shielding kit for the power cables - size A	
CFW500-KPCSB	Shielding kit for the power cables - size B	
CFW500-KPCSC	Shielding kit for the power cables - size C	
CFW500-KPCSD	Shielding kit for the power cables - size D	
CFW500-KPCSE	Shielding kit for the power cables - size E	
CFW500-KPCSF	Shielding kit for the power cables - size F	
CFW500-KPCSG	Shielding kit for the power cables - size G	

Note: 1) Accessory included in the CFW500. Plug in modules can be sold separately as an accessory or spare part.

Accessories

Configuration of the Plug-In Modules¹⁾

Plug-in module	Functions															
	Inputs		Outputs			USB port	Input for Encoder ³⁾	Fieldbus networks							Supply	
	Digital	Analog	Analog	Digital relay	Digital transistor			CANopen DeviceNet	RS232	RS485	Profibus-DP	EtherNet/IP	Modbus-TCP	PROFINET IO	10 V	24 V
CFW500-IOS	4	1	1	1	1	-	-	-	-	1	-	-	-	-	1	1
CFW500-IOD	8	1	1	1	4	-	-	-	-	1	-	-	-	-	1	1
CFW500-IOAD	6	3	2	1	3	-	-	-	-	1	-	-	-	-	1	1
CFW500-IOR-B	5 ²⁾	1	1	4	1	-	-	-	-	1	-	-	-	-	1	1
CFW500-ENC	5 ²⁾	1	1	4	1	-	1	-	-	1	-	-	-	-	1	1
CFW500-CUSB	4	1	1	1	1	1	-	-	-	1	-	-	-	-	1	1
CFW500-CCAN	2	1	1	1	1	-	-	1	-	1	-	-	-	-	1	-
CFW500-CRS232	2	1	1	1	1	-	-	-	1	1	-	-	-	-	-	1
CFW500-CRS485-B	4	2	1	2	1	-	-	-	-	2	-	-	-	-	1	1
CFW500-CPDP	2	1	1	1	1	-	-	-	-	1	1	-	-	-	-	1
CFW500-CETH-IP	2	1	1	1	1	-	-	-	-	1	-	1	-	-	-	1
CFW500-CEMB-TCP	2	1	1	1	1	-	-	-	-	1	-	-	1	-	-	1
CFW500-CEPN-IO	2	1	1	1	1	-	-	-	-	1	-	-	-	1	-	1

Note: 1) All plug-in models have at least one RS485 port. The CFW500-CRS485 plug-in module has two RS485 ports.
The CFW500 allows the installation of one plug-in module per unit.

2) The digital input DI5 is always NPN, and it cannot be configured for PNP like the others.

3) Incremental Encoder (A/A - B/B).

See the installation guides of the plug-in modules on the website www.weg.net



Dimensions and Weights

IP20 Version

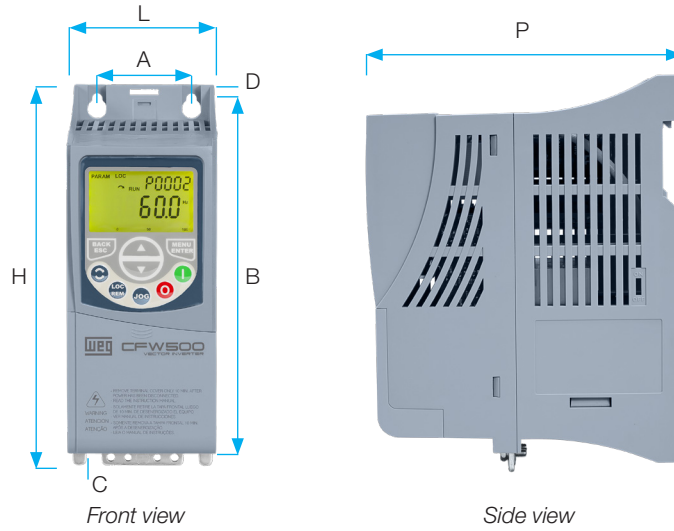

Size	A	B	C	D	H	L	P	Weight
	In (mm)	In (mm)	In (mm)	In (mm)	In (mm)	In (mm)	In (mm)	lb (kg)
A	1.97 (50.0)	6.89 (175.0)	0.47 (11.9)	0.28 (7.2)	7.44 (189.0)	2.95 (75.0)	5.91 (150.0)	1.76 (0.8)
B	2.95 (75.0)	7.30 (185.0)	0.46 (11.8)	0.29 (7.3)	7.83 (199.0)	3.94 (100.0)	6.30 (160.0)	2.65 (1.2)
C	3.94 (100.0)	7.70 (195.0)	0.66 (16.7)	0.23 (5.8)	8.27 (210.0)	5.31 (135.0)	6.50 (165.0)	4.4 (2)
D	4.92 (125.0)	11.41 (290.0)	1.08 (27.5)	0.40 (10.2)	12.07 (306.6)	7.08 (180.0)	6.55 (166.5)	9.48 (4.3)
E	5.90 (150.0)	12.99 (330.0)	1.34 (34.0)	0.41 (10.6)	13.77 (350.0)	8.66 (220.0)	7.53 (191.5)	22.05 (10)
F	7.87 (200.0)	20.67 (525.0)	1.67 (42.5)	0.59 (15.0)	21.65 (550.0)	11.81 (300.0)	10 (254.0)	57.3 (26)
G	7.87 (200.0)	25.59 (650.0)	2.24 (57.0)	0.59 (15.0)	26.57 (675.0)	13.2 (335.3)	12.36 (314)	114.64 (52)

NEMA1 Version



Frame size NEMA1	Height in. (mm)	Width in. (mm)	Depth in. (mm)	Weight lbs. (kg)
A	8.8 (223.0)	3.0 (75.2)	5.9 (149.5)	2.4 (1.1)
B	9.6 (243.3)	3.9 (100.2)	6.3 (160.1)	3.3 (1.5)
C	10.0 (254.8)	5.3 (135.2)	6.5 (165.1)	5.3 (2.4)
D	14.3 (361.9)	7.1 (180.0)	6.6 (166.4)	10.2 (4.6)
E	16.0 (405.7)	8.7 (220.0)	7.5 (191.4)	22.5 (10.4)
F	27.22 (691.4)	11.81 (300)	10.20 (259.2)	60.3 (27.3)
G	27.22 (691.4)	13.2 (335.3)	12.36 (314)	117.2 (53.16)

Standards

Standards	Safety standards	UL 508C - Power conversion equipment
		UL 840 - Insulation coordination including clearances and creepage distances for electrical equipment
		EN 61800-5-1 - Safety requirements electrical, thermal and energy
		EN 50178 - Electronic equipment for use in power installations
		EN 60204-1 - Safety of machinery. Electrical equipment of machines. Part 1: general requirements Note: In order to have a machine in accordance with this standard, the manufacturer of the machine is responsible for installing an emergency stop device and a device for disconnection from the power line
		EN 60146 (IEC 146) - Semiconductor converters
		EN 61800-2 - Adjustable speed electrical power drive systems - Part 2: general requirements - Rating specifications for low voltage adjustable frequency AC power drive systems
	Electromagnetic compatibility standards	EN 61800-3 - Adjustable speed electrical power drive systems - Part 3: EMC product standard including specific test methods
		EN 55011 - Limits and methods of measurement of radio disturbance characteristics of industrial, scientific and medical (ISM) radio-frequency equipment
		CISPR 11 - Industrial, scientific and medical (ISM) radio-frequency equipment - Electromagnetic disturbance characteristics - Limits and methods of measurement
		EN 61000-4-2 - Electromagnetic compatibility (EMC) - Part 4: testing and measurement techniques - Section 2: electrostatic discharge immunity test
		EN 61000-4-3 - Electromagnetic compatibility - Part 4: testing and measurement techniques - Section 3: radiated, radio-frequency, electromagnetic field immunity test
		EN 61000-4-4 - Electromagnetic compatibility - Part 4: testing and measurement techniques - Section 4: electrical fast transient/burst immunity test
		EN 61000-4-5 - Electromagnetic compatibility - Part 4: testing and measurement techniques - Section 5: surge immunity test
	EN 61000-4-6 - Electromagnetic compatibility - Part 4: testing and measurement techniques - Section 6: immunity to conducted disturbances, induced by radio-frequency fields	
	Mechanical construction standards	EN 60529 - Degrees of protection provided by enclosures (IP code)
		UL 50 - Enclosures for electrical equipment
		IEC60721-3-3 - Classification of environmental conditions - part 3: classification of groups of environmental parameters and their severities - Section 3: stationary use at weather protected locations level 3M4.



Technical Specifications

Power rating	Power supply	Tolerance: -15 to +10%	
		Frequency: 50/60 Hz (48 Hz to 62 Hz)	
		Phase imbalance: ≤3% of the rated phase-phase input voltage	
		Transient voltages and overvoltages according to Category III (EN 61010/UL 508C)	
		Maximum of 10 (line) connections per hour (1 every 6 minutes)	
Control	Method	V/F (scalar) VW: voltage vector control Vector without encoder (sensorless) and closed loop vector with encoder PM VW: voltage vector control for permanent magnet motors	
		Output frequency	0 to 500 Hz, resolution of 0.015 Hz
	Performance	V/F Control	Speed regulation: 1% of the rated speed (with slip compensation) Speed variation range: 1:20
Vector control (VW)		Speed regulation: 1% of the rated speed Speed variation range: 1:30	
Sensorless		Speed regulation: 0.5% of the rated speed Speed variation range: 1:100	
Vector control with Encoder		Speed regulation: 0.1% of the rated speed Speed variation range: 1:100	
PM VW Control		Regulation: 0,1 % of the rated speed Speed variation range: 1:20	
Environment conditions	Temperature around the CFW500	-10 °C to 50 °C - IP20 (sizes A to E) -10 °C to 40 °C - IP20 (sizes A to E) when installed by side -10 °C to 40 °C - NEMA 1 (sizes A to E) -10 °C to 40 °C - IP20, NEMA 1 (size F) -10 °C to 45 °C - IP20, NEMA 1 (size G) For sizes A to E, when operating temperatures are above the specification, it is necessary to apply 2% of current derating for each Celsius degree (°C), limited to an increase of 10 °C. For size F and G, when operating temperatures are above the specification, it is necessary to apply 1% of current derating for each Celsius degree (°C) up to 50 °C, and 2% up to 60 °C (maximum).	
		Aggressive environments	Protection Class 3C2 - Standard coating on the internal circuits, according to IEC 60721-3-3 (standard model) Protection Class 3C3 - Extra coating - optional, according to IEC 60721-3-3 (optional)
		Air relative humidity	5% to 95% non-condensing
		Altitude	Up to 1,000 m (maximum altitude under normal conditions) 1,000 to 4,000 m: current derating of 1% for each 100 m above 1,000 m of altitude
		Pollution degree	2 (EN 50178 and UL 508C), with non-conductive pollution Condensation must not cause conduction of the accumulated residues
Inputs ¹⁾	Analog	1 isolated input. Levels: (0 to 10) V or (0 to 20) mA or (4 to 20) mA Linearity error ≤0.25% Impedance: 100 kΩ for voltage input, 500 Ω for current input Programmable functions, including PTC input Maximum voltage accepted in the inputs: 30 V dc	
	Digital	4 isolated inputs Programmable functions: Active high (PNP): maximum low level of 15 V dc; minimum high level of 20 V dc Active low (NPN): maximum low level of 5 V dc; minimum high level of 9 V dc Maximum input voltage of 30 V dc Input current: 4.5 mA Maximum input current: 5.5 mA	
Outputs ¹⁾	Analog	1 isolated output. Levels (0 to 10) V or (0 to 20) mA or (4 to 20) mA Linearity error ≤0.25% Programmable functions RL ≥10 kΩ (0 to 10 V) or RL ≤500 Ω (0 to 20 mA / 4 to 20 mA)	
	Relay	1 relay with NO/NC contact Maximum voltage: 240 V ac Maximum current of 0.5 A Programmable functions	
	Transistor	1 isolated open sink digital output (using as reference the 24 V dc power supply) Maximum current of 150 mA (maximum capacity of the 24 V dc power supply) ²⁾ Programmable functions	
	Power supply	24 V dc power supply. Maximum capacity: 150 mA ²⁾ Power supply of 10 V dc. Maximum capacity: 2 mA	
Communication	Selectable plug-in	Fieldbus: Modbus-RTU, CANopen, DeviceNet, Profibus-DP, EtherNet/IP, Modbus-TCP, PROFINET IO USB, RS485 and RS232 ports	
Safety	Protection	Phase-phase overcurrent/short circuit in the output Phase-ground overcurrent/short circuit in the output Undervoltage/overvoltage in the power Overtemperature of the heatsink Motor overload Overload on the power module (IGBTs) External fault / alarm Programming error	
Operating interface (keypad)	Standard (built in the CFW500)	9 keys: Run/Stop, Increment, Decrement, Direction of rotation, Jog, Local/Remote, Back/Esc and Enter/Menu LCD Display It allows accessing/changing all the parameters Accuracy of the indications: Current: 5% of the rated current Speed resolution: 0.1 Hz	
Protection degree	IP20	Sizes A, B, C, D, E, F and G	
	NEMA1	Sizes A, B, C, D, E, F and G with NEMA1 kit	

Notes: 1) The number and/or types of analog/digital inputs/outputs may vary according to the plug-in module (accessory) used. In the table above, the standard plug-in module (CFW500-IOS) was taken into account. For further information, refer to the CFW500 user manual.

2) The maximum capacity of 150 mA considers the load of the 24 V power supply plus the transistor output, that is, the sum of the consumption of both must not exceed 150 mA.

Block Diagram of CFW500-IP20 or NEMA1 Version

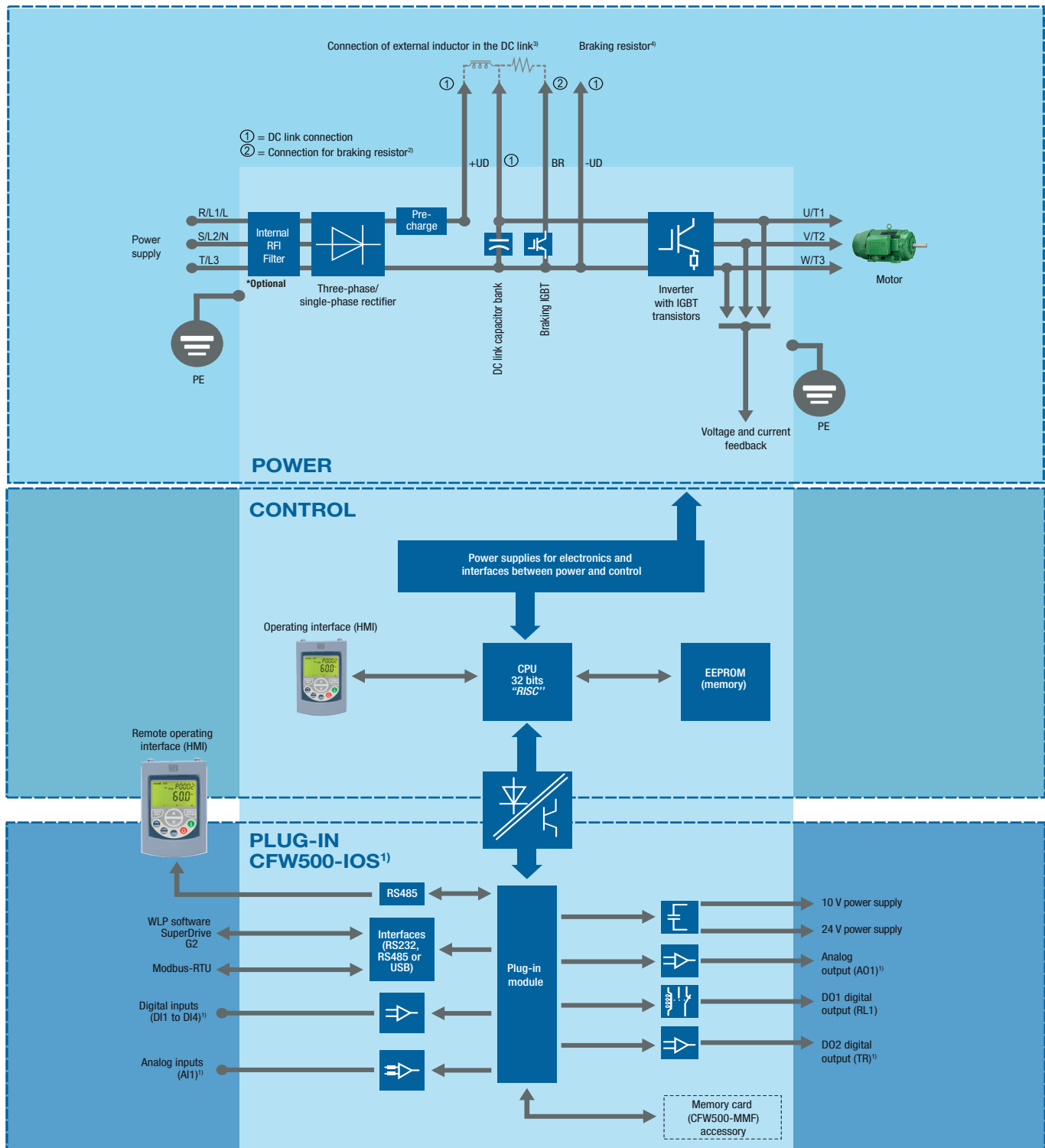

Notes: 1) The number of inputs and outputs (analog and digital), as well as other resources, may vary according to the plug-in module used. For further information, refer to the CFW500 user manual.

2) Not available for size A.

3) Connection available for sizes D and E only. Inductor on the DC link not included. Sizes F and G have DC link inductor built-in as standard, to protect the drive against current spikes.

4) Resistor not included. Internal dynamic braking (IGBT) built-in the whole line, except for frame size A of IP20 / NEMA1 version.



WEG Electric Corp. offers the following products, and more! With a full range of IEC/NEMA Global Certifications and a full line of products, WEG can supply the right solution for your needs anywhere in the world. To learn more about WEG's products and solutions or to locate a Distributor near you, please call **1-800-ASK-4WEG** or visit **www.weg.net**.

Low Voltage Motors, Single and 3-Phase, 1/8 – 700HP

- General Purpose Motors
- Explosion Proof Motors
- Crusher Duty Motors
- IEC Tru-Metric Motors
- Pump Motors including JP/JM
- P-Base Pump Motors
- Oil Well Pumping Motors
- Pool & Spa Motors
- Brake Motors
- Compressor Duty Motors
- Farm Duty Motors
- Poultry Fan Motors
- Auger Drive Motors
- IEEE 841 Motors
- Stainless Steel Wash Down Motors
- Saw Arbor Motors
- Cooling Tower Motors
- Commercial HVAC Motors
- Pad Mounted Motors
- Vector Duty Motors

Large Electric Motors

- Low Voltage 3-phase motors up to 2,500HP
- Induction Motors up to 70,000HP and 13,200V
- Wound Rotor Systems (including starters) up to 70,000HP and 13,200V
- Synchronous Motors up to 200,000HP and 13,200V
- Explosion proof motors (Ex-d) up to 1,500kW and 11kV
- Ex-n, Ex-e, Ex-p motors

Variable Frequency Drives

- Low Voltage 1/4 to 2500HP, 230V – 480V
- Medium Voltage 500-10,000HP
- Multi-pump systems
- NEMA 4X
- Dynamic braking resistors
- Line and load reactors
- Plug and play technology
- Network communications: Profibus-DP, DeviceNet, Modbus-RTU
- PLC functions integrated
- Complete line of options and accessories

Soft Starters

- 3-1500HP
- Oriented start-up
- Built-in bypass contactor
- Universal source voltage (230-575V, 50/60Hz)
- Network communications: Profibus-DP, DeviceNet, Modbus-RTU
- Complete Line of options and accessories
- MV Soft-starter 3.3kV, 4.16kV: up to 3500HP, Withdrawable Power Stacks, & 8x PT100 Temperature monitoring

Controls

- Mini – Contactors
- IEC Contactors
- Thermal Overload Relays
- Manual Motor Protectors
- Molded Case Circuit Breakers
- Smart Relays
- Enclosed Starters: combination & non-combination
- Pushbuttons & Pilot Lights
- Timing & Motor Protection Relays
- Terminal Blocks

Custom Panels

- Custom configured to your specification.
- NEMA 1, 12, 3R, 4 and 4X cabinets
- Quick delivery of preconfigured drives and soft starters
- UL 508 certified
- Low Voltage (230-460)
- Made in the U.S.A.

Generators

- Brushless Synchronous Generators for diesel gen-sets up to 4,200kVA
- Hydro-generators up to 25,000kVA
- Turbo-generators up to 175,000kVA

Power Transformers

- Built and engineered in North America
- Voltages < 345kV
- Ratings 5-250MVA
- Station class, oil filled, round core, copper windings
- Special configurations and designs available!
- Ask your WEG Sales Representative for details.
- Designed, built, and engineered to ANSI standards.

Custom Solution Package Sales

- WEG can package any of its products for ease of sale! Enjoy a single point of contact for the entire package of products and assistance from quote through after-sales support. Ask your WEG Sales Representative for details.



WEG Electric Corp.
6655 Sugarloaf Parkway
Duluth, GA 30097
Phone: 1-800-ASK-4WEG
www.weg.net

Please contact your authorized distributor:

