

WG20

Geared Motors up to 159,300 lb-in

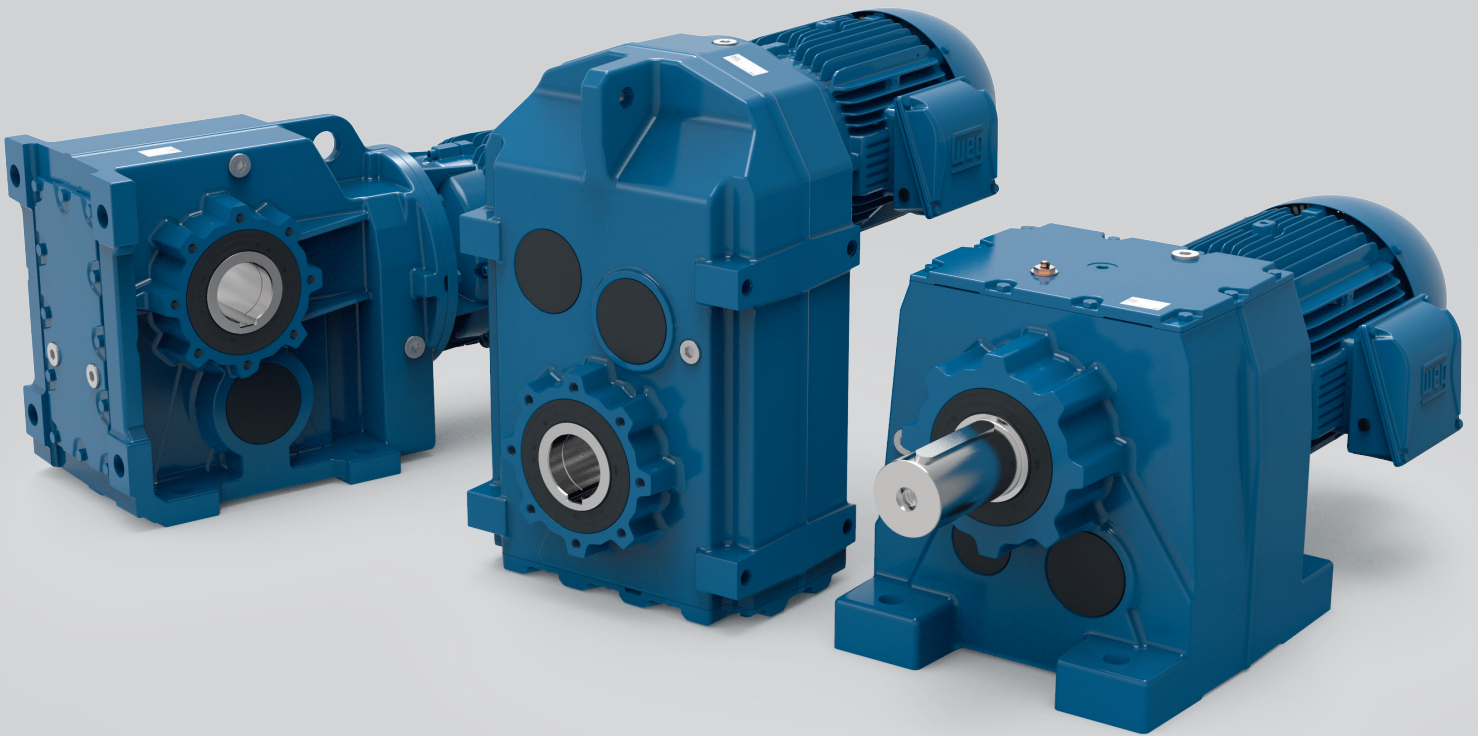



WEG Group - Transforming energy into solutions.

WEG is a leading global manufacturer and solutions provider of drive technology, energy production and distribution, and automation systems and switchgear construction.

Founded in Brazil in 1961 by three entrepreneurs, WEG has grown to become one of the most important global manufacturers of electric motors. WEG has more than 30,000 employees around the world. The annual turnover of around 3.5 billion dollars reflects its increasing success. The company's global presence is supported by branches in 29 countries, production facilities, and a network of authorized dealers on all five continents.

Your requirements - our expertise

As one of the leading global manufacturers and solutions providers of drive technology, WEG's aim was to expand its extensive range of products with the addition of gearboxes produced in its own facilities. Perfect coordination of products throughout the drive train has put WEG in a position to offer customers an even greater and more complete range of solutions.

Under the leadership of Watt Drive, the challenge was to develop a program which not only meets the current demands of the market, but also satisfied WEG's high quality requirements. The Group's own center of excellence for geared motors in Austria, part of the WEG Group since 2011, can draw on more than 40 years of experience in development, production and sales of gear reducers and geared motors.

In order to satisfy the requirements of state-of-the-art geared motors the following market requirements were taken into account during the development phase:

Standard mounting dimensions

For users, the aim was to make the new range of geared motors as easy and effortless to use as possible. To ensure installation in an existing system or production line worked effortlessly without incurring unnecessary costs for conversions, the developers decided to adapt the

mounting dimensions of the new geared motors to products already established on the market. The objective: worldwide, easy and cost-effective interchangeability.

Torque transmission

The geared motors needed to be compact, efficient, robust and reliable. In order to achieve this goal a transmission had to be designed which allows large ratio ranges in a two-stage model while being able to integrate easily into the newly designed gear housing.

Efficiency

Energy efficiency has always been of paramount importance to WEG. The aim here was to live up to this demand when designing the new WG20 geared motors. This requires the perfect interaction of sophisticated technology and exclusive use of high quality components.

Worldwide use

To meet the requirements of global mechanical and plant engineering, it was vital that the new geared motors are capable of being used worldwide, while maintaining a high level of flexibility for applications.

The solution is **WG20**.



WG20 - a new generation of geared motors

WG20 is the first geared motor range to be completely developed in-house at WEG. It comprises helical, parallel shaft and helical bevel geared motors with torques between 440 and 159,300 lb-in. The two-stage units excel with their large ratio range, as well as being exceptionally efficient thanks to the sophisticated design. The light aluminium housings of the geared motors up to 5300 lb-in and the robust cast iron housings from 7250 lb-in provide a highly versatile and reliable product, with a wide range of possible applications.



Highly efficient

The geared motors are available in a two-stage design featuring a large ratio range, which in turn makes them highly efficient.

Furthermore, the products of the WG20 series demonstrate extremely low power losses. On the one hand, this is achieved by low circumferential speeds in the input stage and, on the other hand, by reducing splashing losses due to optimized amounts of lubricant. These characteristics also have a positive effect on the gear lifetime. Under normal conditions of use, the geared motors up to 5300 lb-in are maintenance-free and lubricated for life.



In line with market requirements

For maximum user convenience, the housing of the new gearbox series has been designed in keeping with market requirements. The crucial mounting dimensions of the design correspond with the specifications already established on the market which allows for direct exchange. This means that WG20 geared motors are not only suitable for use in new applications, but can also be easily integrated into existing systems as a replacement or for optimization purposes.

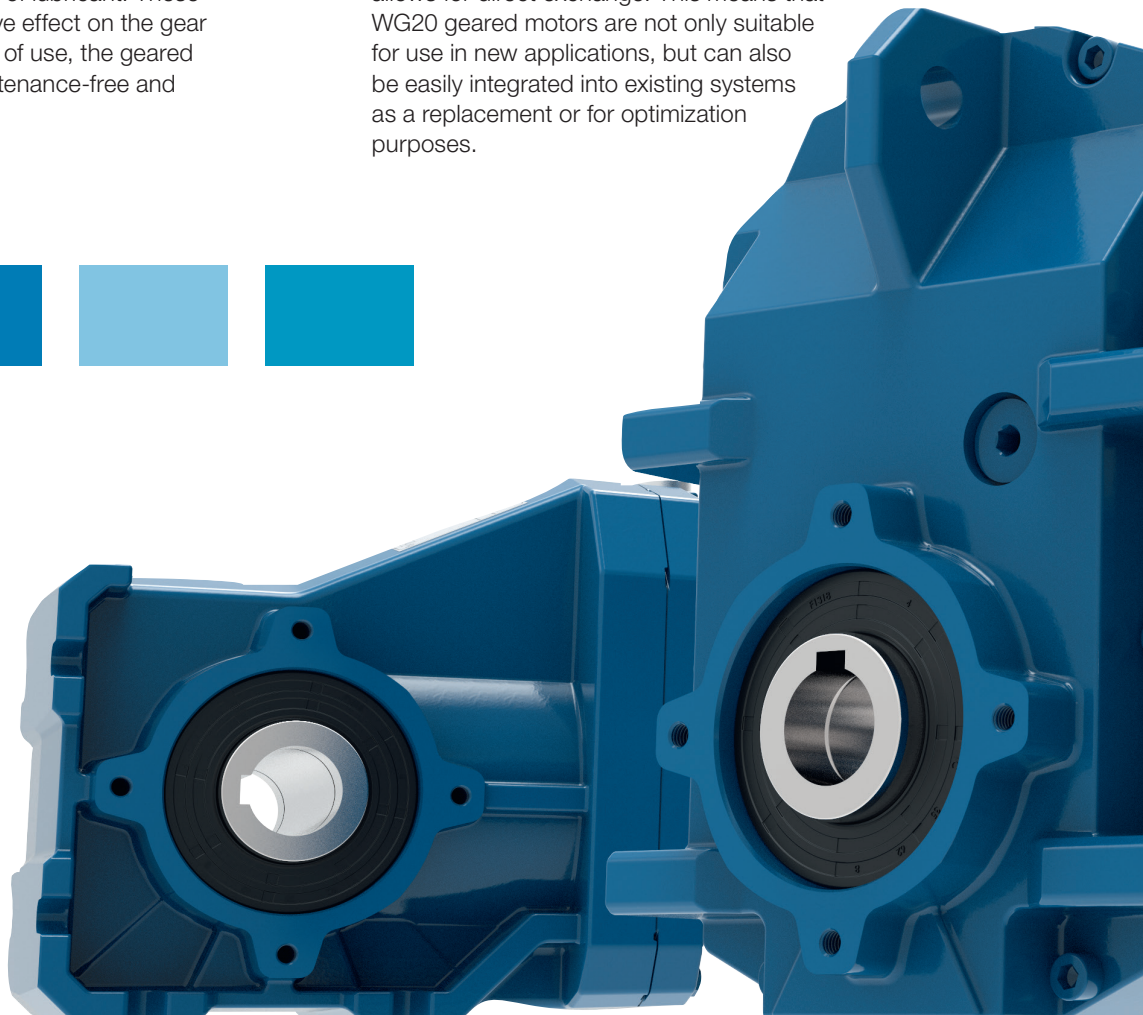



Optimized design

When designing the new gearbox range, the designers paid particular attention to develop a robust housing, opting for a light aluminium construction for the frame sizes up to 5300 lb-in. The die casting process used in production not only benefits from a smooth surface for demanding hygienic applications, but also features excellent heat conductivity. The housing design additionally enhances this property. The intelligently designed surface encourages heat dissipation from the internal gear parts, thereby aiding more efficient operation and a longer life.

The housings for frame sizes from 7250 lb-in and larger are fabricated in MONOBLOC design and made of cast iron, making them especially sturdy and torsionally stiff.

Gear teeth geometry has also been refined. Calculations applying the finite element method have optimized gear teeth safety, especially in the tooth base area. High quality standards in the gear wheel production process not only ensure a sound and smooth operation, but also increased durability.

The overall compact design also affects the amount of lubricant used, helping to conserve resources when handling raw materials. Due to the arrangement of gearing and optimized housing interior, only low levels of oil are necessary in the gearbox.

WEG has also achieved improvements on the input side. The end shields and terminal box of motors up to frame size 132 are now made of light aluminium which considerably reduces the weight of the geared motor. For frame sizes 160 through 250 cast iron motors are used which are based on the latest W22 motor technology.

Furthermore, the terminal box dimensions have been increased for ease of access.



Less noise

The WG20 series gearboxes are characterised by their smooth, quiet operation.

High quality components, which originate almost exclusively from in-house production, engage perfectly to provide the basis for guaranteed low noise operation. Even the flexible gear wheel construction helps reduce noise emission. The small motor pinion allows for lower circumferential speeds in the first stage and reduced noise emissions.

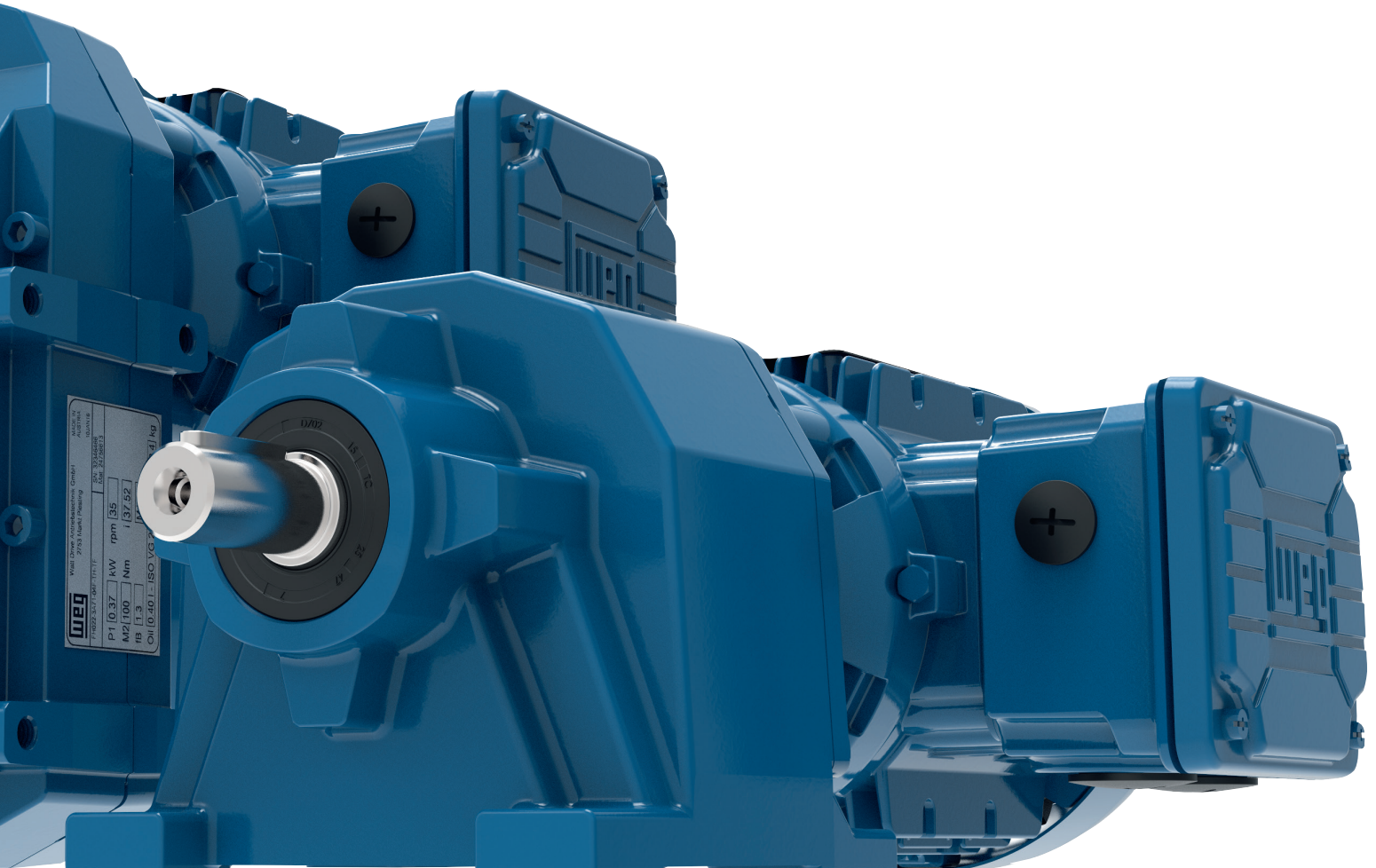

Helical geared motors C

The helical geared motors come in twelve housing sizes for nominal torques from 440 to 159,300 lb-in and are available in both foot and flange designs. While the two smaller geared motors (C00 and C01) are able to perform to their full potential with just two stages, the larger C03 to C16 are available in both two and three-stage versions, for those applications in higher torque ranges.

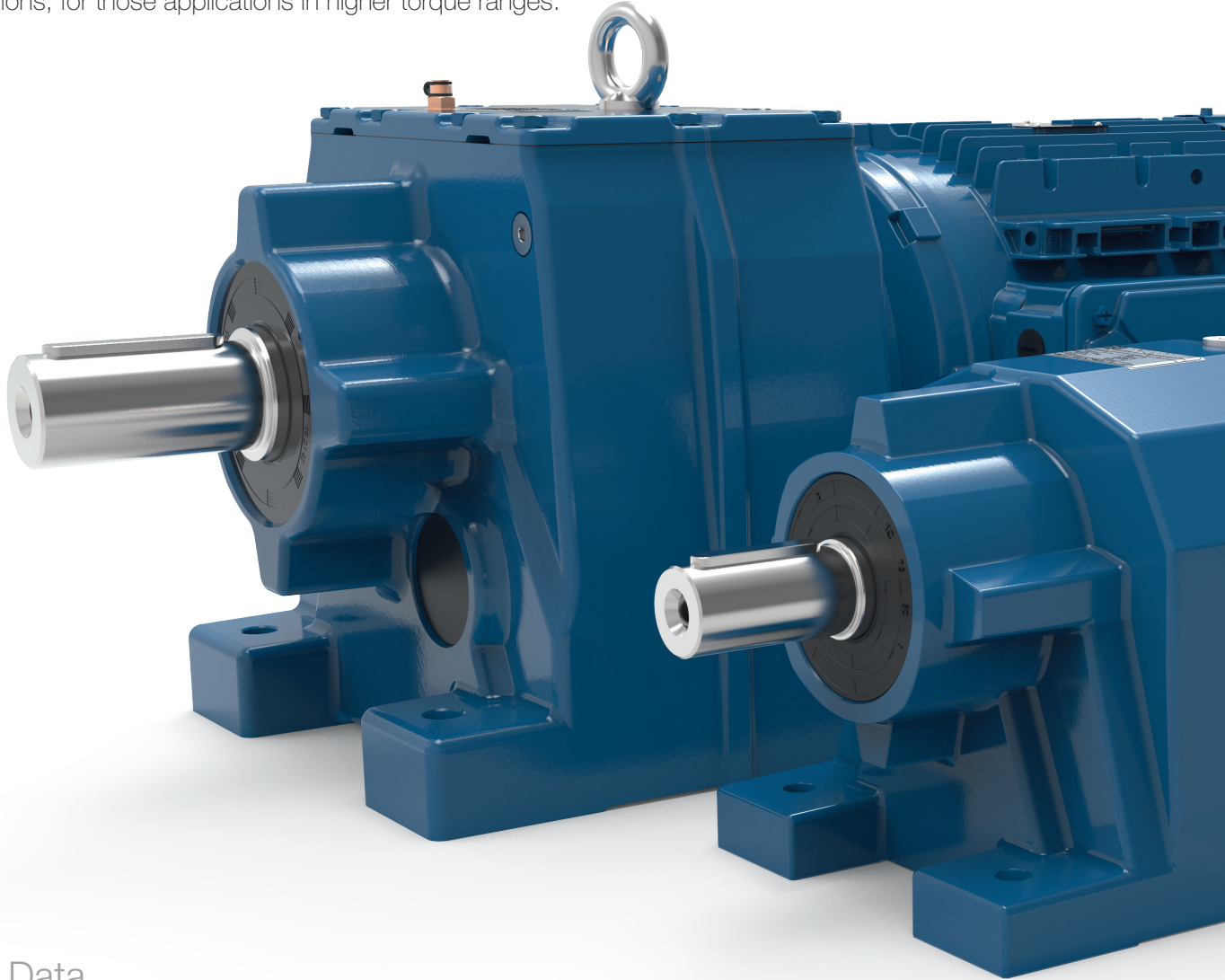

Technical Data

		C00	C01	C03	C05	C06	C07	C08	C09	C10	
Nominal torque	[lb-in]	440	750	1760	3540	5300	7250	13700	26500	39800	
Number of stages		2-stage	2-stage	2-/3-stage	2-/3-stage	2-/3-stage	2-/3-stage	2-/3-stage	2-/3-stage	2-/3-stage	
Ratio range		2.44 - 47.44	3.09 - 66.50	3.34 - 286.32	3.83 - 328.43	3.73 - 375.71	5.30 - 351.33	5.12 - 368.94	4.22-306.73	4.19-246.43	
Speed range at 1750 rpm 60Hz	[rpm]	37 - 717	26 - 566	6 - 524	5 - 457	5 - 469	5 - 330	5 - 342	6 - 415	7 - 418	
Power range 60 Hz	[hp]	0.16 - 1	0.16 - 2	0.16 - 4	0.16 - 10	0.16 - 12.5	0.16 - 20	0.25 - 30	0.75 - 40	1.50 - 40	
Output shaft	[in]	0.750 x 1.57	0.750 x 1.57	1.000 x 1.97	1.250 x 2.36 1.375 x 2.76	1.375 x 2.76	1.625 x 3.15	2.125 x 3.94	2.375 x 4.72	2.875 x 5.51	
Output flange IEC	[mm]	120/140/160	120/140/160	120/140/ 160/200	160/200/250	200/250	250/300	300/350	350/450	350/450	
Housing material		Aluminium					Cast iron				

Design versions

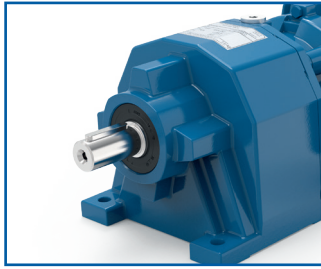

Foot

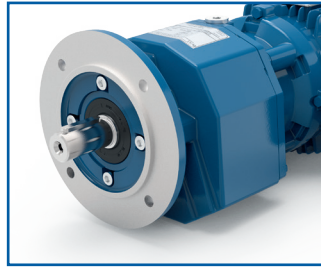

Flange

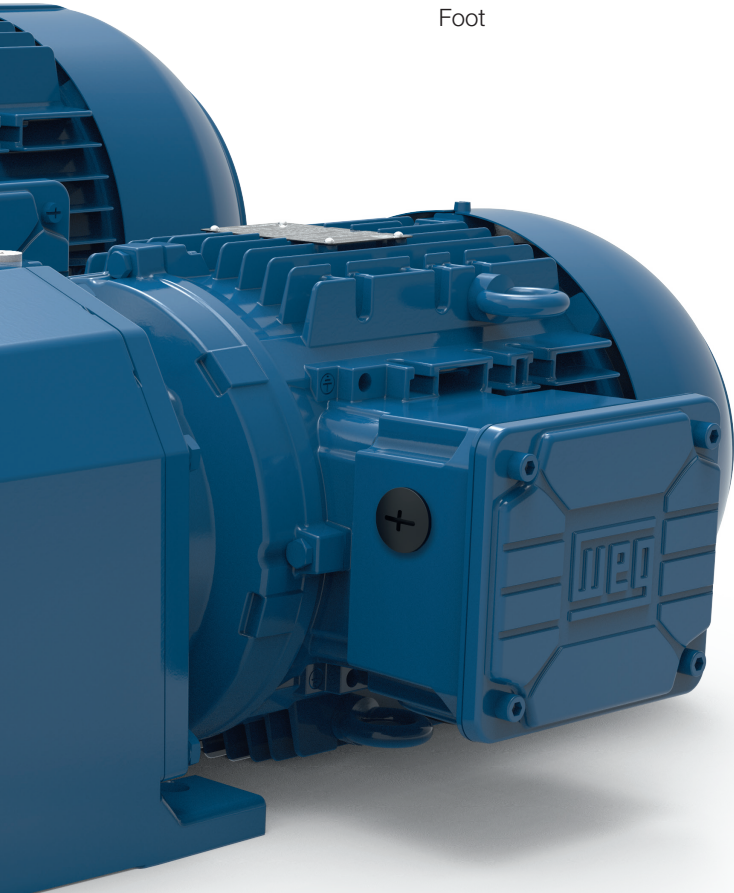

Standard mounting dimensions

Taking the most significant standard mounting dimensions available into account, the design allows for easy integration of WG20 geared motors into almost any existing system.

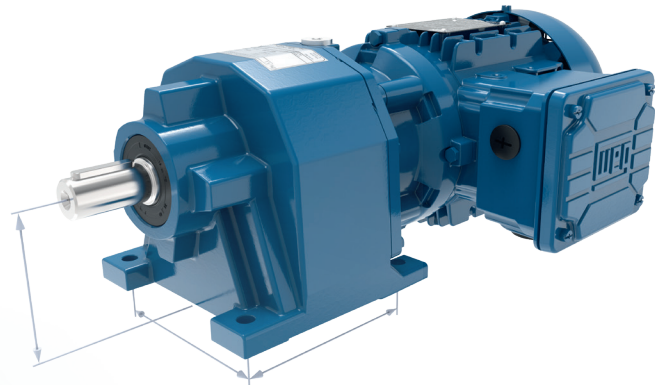

Typical areas of application

Machines for timber processing companies, presses, conveyor belts, rotary tables, pumps, packaging machines, bakery equipment, lifts, looms, screw conveyors and screw compressors.

C13	C14	C16
70800	115000	159300
2-/3 stage	2-/3 stage	2-/3 stage
4.00 - 204.88	5.17 - 206.88	5.96 - 234.67
8 - 438	8 - 338	7 - 294
5 - 75	5 - 75	8 - 100
3.625 x 6.69	4.375 x 8.27	4.750 x 8.27
450/550	450/550	550/660
Cast Iron		

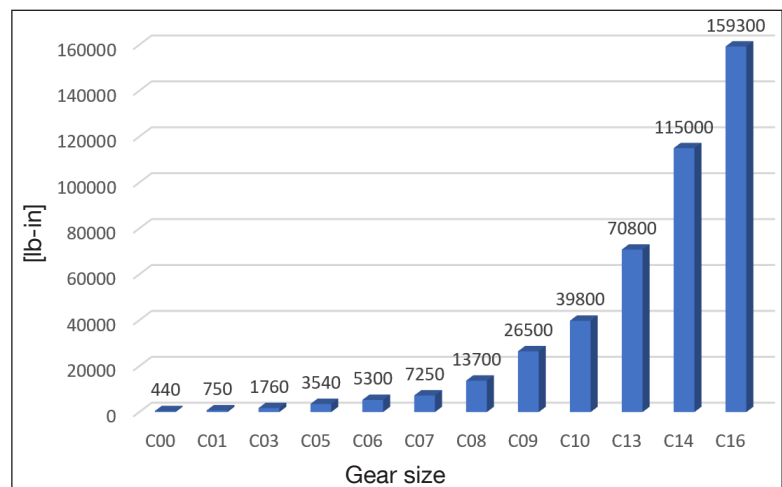

Parallel shaft geared motors F

Thanks to their structural design, parallel shaft gear units are particularly suitable for conveyor technology applications. All eleven sizes can be fitted with either a hollow shaft, output shaft, mounting flange or shrink disc. The ratio range of gear unit sizes F04 to F15 can be extended by a third gear stage.

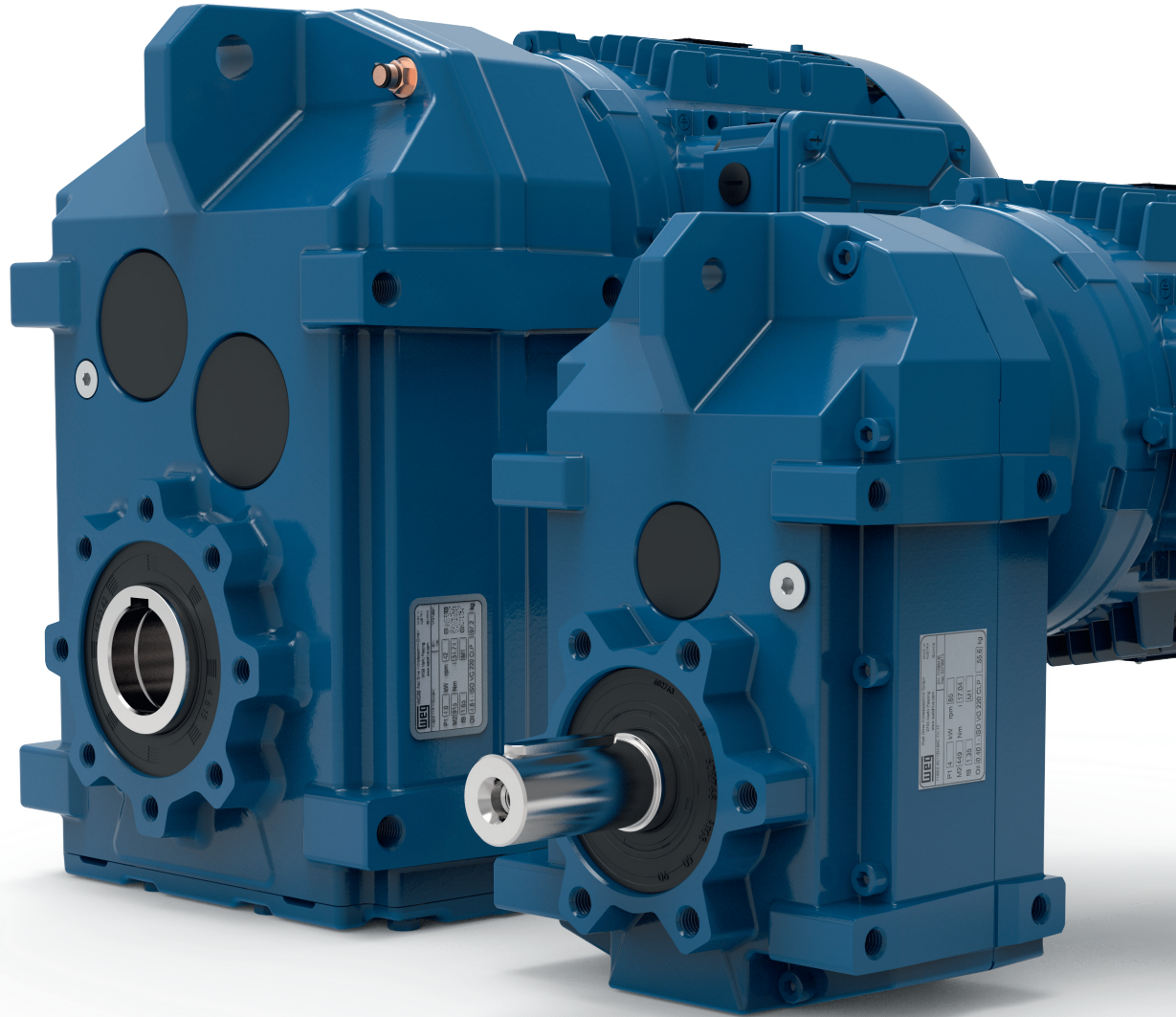

Technical Data

		F02	F03	F04	F05	F06	F07	F08	F09
Nominal torque	[lb-in]	1150	1940	3540	5300	7250	13700	26500	39800
Number of stages		2-stage	2-stage	2-/3-stage	2-/3-stage	2-/3-stage	2-/3-stage	2-/3-stage	2-/3-stage
Ratio range		3.93 - 97.85	3.85 - 70.17	4.42 - 422.98	5.17 - 487.67	4.41 - 412.64	4.29 - 305.42	4.09 - 358.52	4.16 - 288.50
Speed range at 1750 rpm 60 Hz	[rpm]	18 - 445	25 - 455	4 - 396	4 - 338	4 - 397	6 - 408	5 - 428	6 - 421
Power range 60 Hz	[hp]	0.16 - 2	0.16 - 4	0.16 - 4	0.16 - 12.5	0.16 - 20	0.16 - 20	0.75 - 30	0.75 - 40
Output shaft/ Ø hollow shaft	[in]	1.000 x 1.97 / 1.000	1.000 x 1.97 / 1.250	1.250 x 2.36 / 1.375	1.375 x 2.76 / 1.500	1.625 x 3.15 / 1.500	2.000 x 3.94 / 2.000	2.375 X 4.72 / 2.375	2.875 x 5.51 / 2.75
Output flange IEC	[mm]	160	160	200	250	250	300	350/450	350/450
Housing material		Aluminium				Cast iron			

Design versions

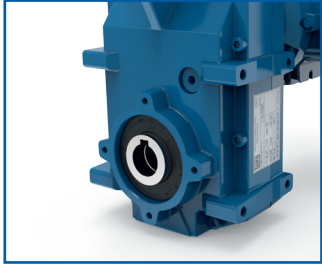

Hollow shaft

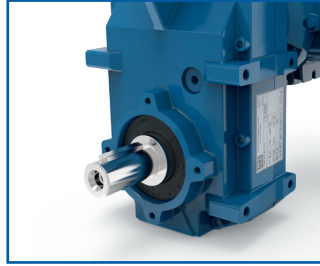

Output shaft

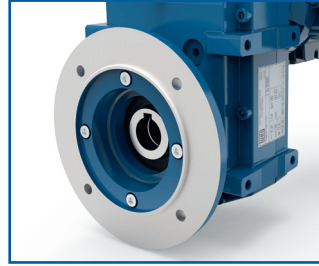

Flange

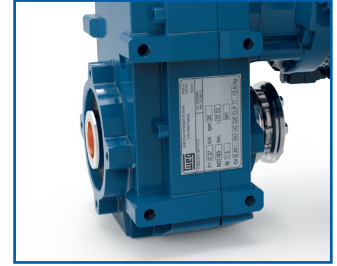

Shrink disc



Standard mounting dimensions

Taking the most significant standard mounting dimensions on the market into account, the design allows for the easy integration of WG20 geared motors into almost any existing system.

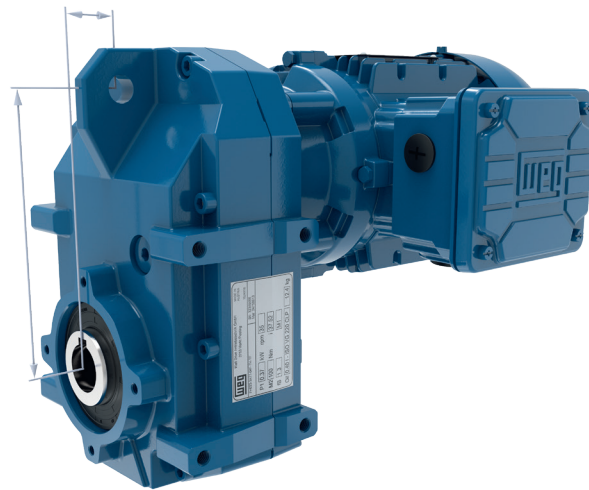

Typical areas of application

Machines for waste disposal and recycling, roller conveyors and laminating machines, machinery for timber processing companies, agitators, mixing equipment, stacking equipment, separators, screw conveyors, travel drives for cranes, welding equipment and surface aerators.

F10	F12	F15
70800	115000	159300
2-/3 stage	2-/3 stage	2-/3 stage
4.38 - 246.57	4.64 - 220.67	5.84 - 259.81
7 - 400	8 - 377	7 - 300
5 - 75	5 - 75	15 - 100
3.625 x 6.69 / 3.625	4.375 x 8.27 / 4.00	4.750 x 8.27 / 4.500
450	550	660
Cast iron		

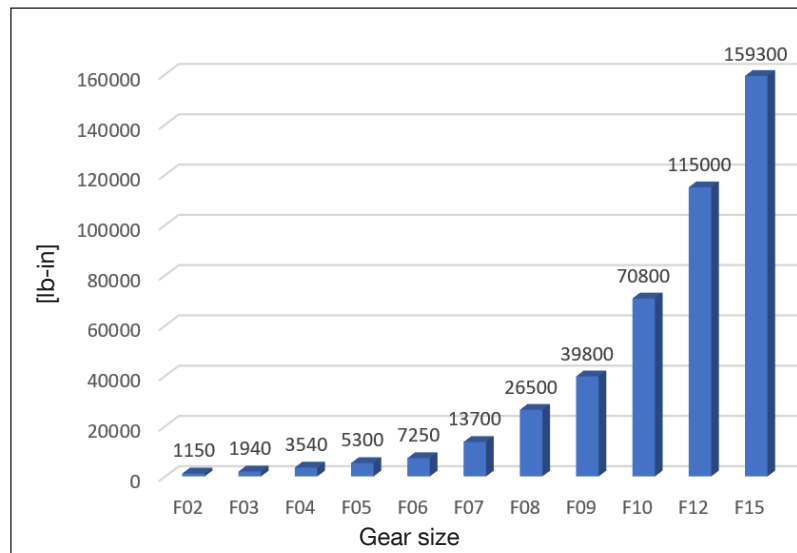

Helical bevel geared motors K

Helical bevel geared motors are suitable for a multitude of applications. The two-stage basic design is extended by a third gear stage upward of 1760 lb-in. K geared motors can also be equipped with a hollow shaft, output shaft, shrink disc, torque arm and mounting flange.

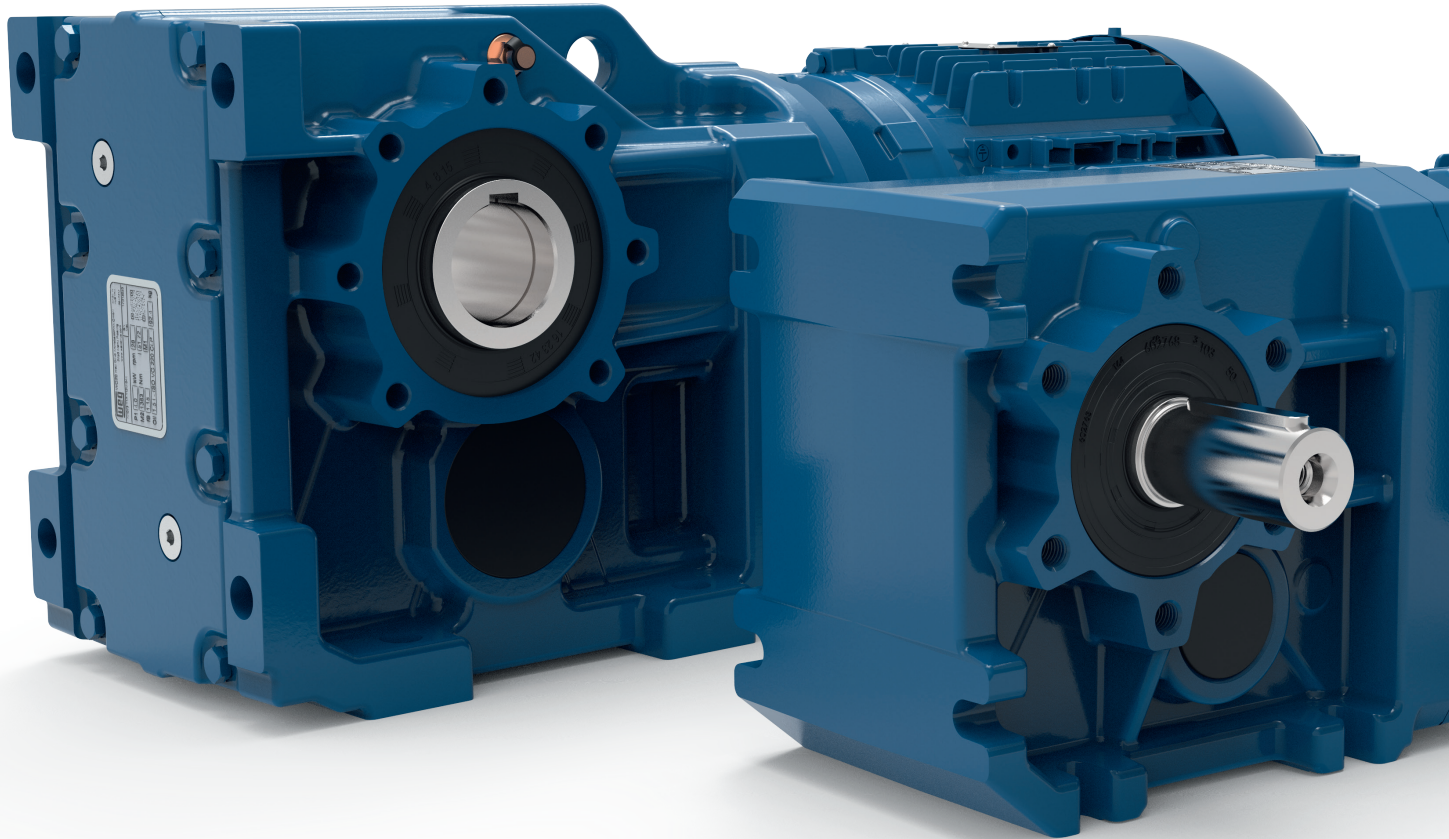

Technical Data

		K02	K03	K04	K05	K06	K07	K08	K09
Nominal torque	[lb-in]	970	1760	3540	5300	7250	13700	26500	39800
Number of stages		2-stage	3-stage	3-stage	3-stage	3-stage	3-stage	3-stage	3-stage
Ratio range		3.82 - 68.88	4.17 - 217.88	5.05 - 277.79	4.27 - 245.70	4.94 - 198.00	7.19 - 256.14	7.45 - 206.12	6.94 - 169.25
Speed range at 1750 rpm 60 Hz	[rpm]	25 - 458	8 - 420	6 - 347	7 - 410	9 - 354	7 - 243	8 - 235	10 - 252
Power range 60 Hz	[hp]	0.16 - 2	0.16 - 4	0.16 - 5.5	0.16 - 12.5	0.25 - 12.5	0.33 - 20	0.75 - 30	1.50 - 40
Output shaft/ Ø hollow shaft	[in]	1.000 x 1.97 / 1.000	1.000 x 1.97 / 1.250	1.250 x 2.36 / 1.375	1.375 x 2.76 / 1.500	1.625 x 3.15 / 1.500	2.000 x 3.94 / 2.000	2.375 X 4.72 / 2.375	2.875 x 5.51 / 2.75
Output flange IEC	[mm]	160	160	200	250	250	300	350/450	350/450
Housing material		Aluminium				Cast iron			

Design versions

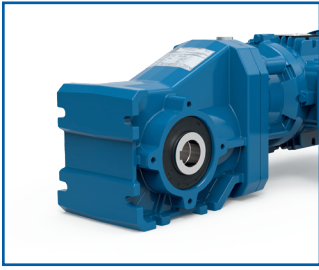

Hollow shaft

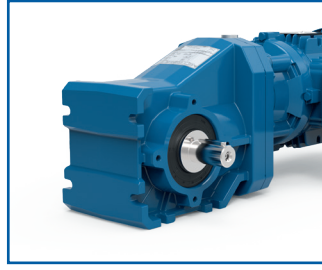

Output shaft

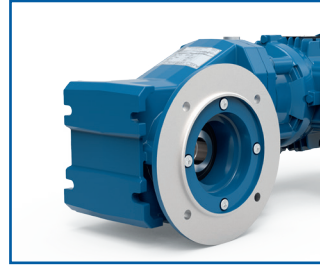

Flange

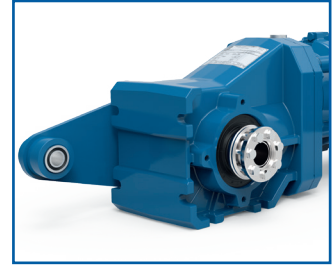

Shrink disc and torque arm

Standard mounting dimensions

Taking the most significant standard mounting dimensions on the market into account, the design allows for easy integration of WG20 geared motors into almost any existing system.

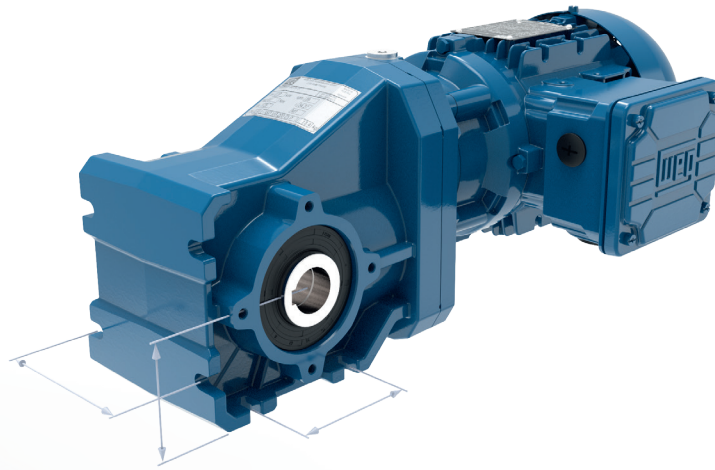
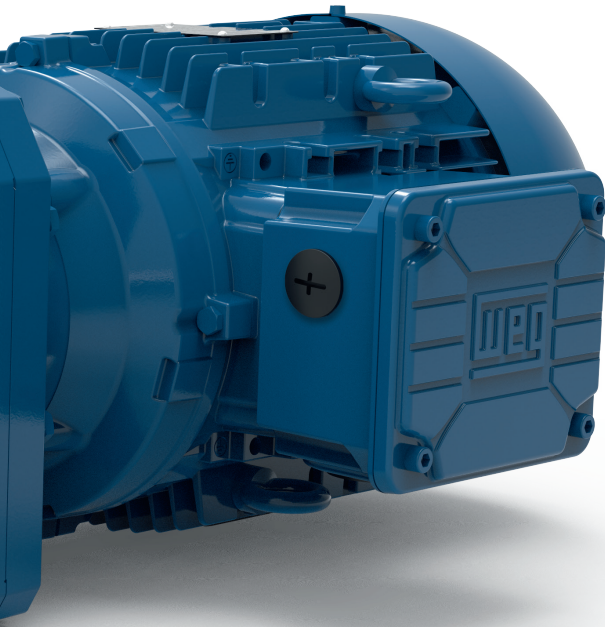

Typical areas of application

Roller tables and laminating machines, agitators, winches, lifts, heavy duty conveyors for bulky goods, shredders, conveyor belts, baggage handling systems, scenery lifts for stage machinery, bulk material and unit conveyors, and concrete mixing plants.

K10	K12	K15
70800	115000	159300
3-stage	3-stage	3-stage
6.64 - 140.95	6.60 - 151.11	8.61 - 146.69
12 - 264	11 - 265	12 - 203
5 - 75	5 - 75	15 - 100
3.625 x 6.69 / 3.625	4.375 x 8.27 / 4.00	4.750 x 8.27 / 4.500
450	550	660
Cast iron		

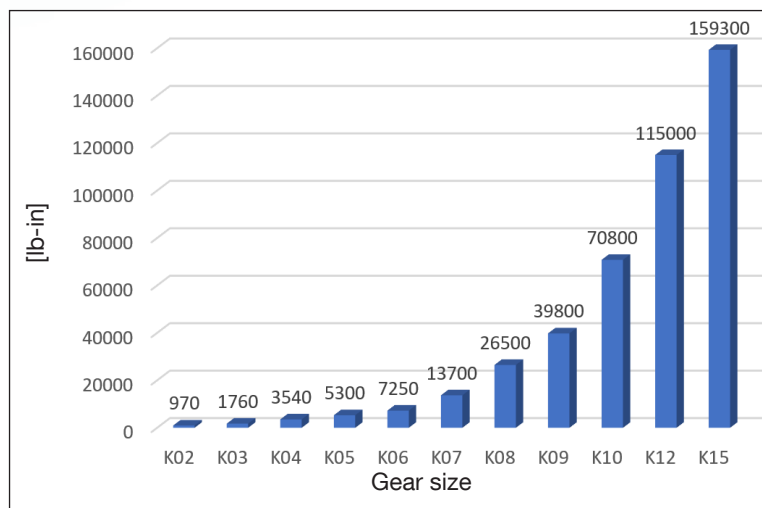

Aluminium modular integral motor

The latest generation of WEG aluminium motors up to frame size 132 excels due to the user-friendly design to efficiency class IE3 and the reliable quality in various industrial sectors. The optimized design of the end shields and aluminium terminal box also results in a crucial reduction in weight. Thanks to the special wide-range winding and nine-bolt terminal block, flexible use anywhere in the world is guaranteed.

Technical Data (standard)

Power output	0.16 to 10 hp
Number of poles	4 and 6
IEC frame sizes	63 to 132
Voltages	110-480 V, 50/60 Hz
Efficiency class	IE1, IE3
Thermal class	F
Protection class	IP55
Housing material	Aluminium
Thermal protection	Bi-metal switch and thermistor protection PTC
Inverter operation	up to 460 V
Certificates	CE, UL/CSA, EAC

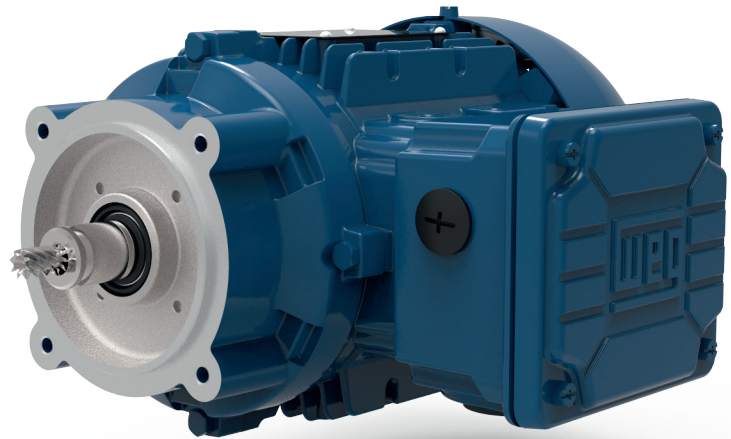

120 Hz characteristic - double the power

Modular motors up to frame size 250 are perfect for operation with electronic speed control. The 87/100/120 Hz voltage/frequency characteristic allows them to be operated in frequency inverter mode even without special windings. This allows the nominal output to be doubled without losing torque.

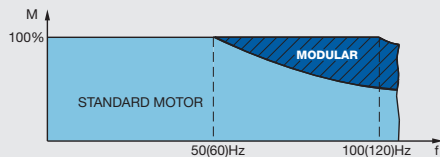

Rated (nominal) torque to double rated (nominal) speed

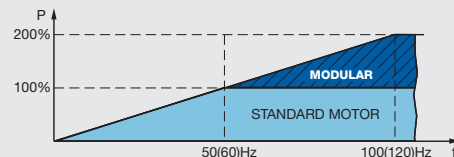

Double rated (nominal) power at twice the rated (nominal) speed

Just switch over and use worldwide

The special wide-range winding of the motor enables selection of up to four different voltage levels (star, delta, double star, and double delta) by means of twelve connection slots on the 9-bolt terminal block. This allows modular motors to be used with almost any mains voltage and frequencies worldwide. Furthermore, the terminal box dimensions have been changed for ease of access.



Cast iron modular integral motor

The newly developed integral motors in frame sizes 160 through 250 are members of the latest generation of the W22 motor family. Due to their innovative design, these motors guarantee maximum value to the user and perform with highest efficiency and reliability. The three-phase motors with power output of 15 to 100 hp are available up to energy efficiency class IE4, they can be mains operated and are certified for use in all important markets worldwide.

Technical Data (standard)

Power output	15 to 100 hp
Number of poles	4
IEC frame sizes	160 to 250
Voltages	190-690 V. 50/60 Hz
Efficiency class	up to IE4
Thermal class	F
Protection class	IP55
Housing material	Cast iron
Thermal protection	Thermistor protection PTC
Inverter operation	up to 460 V
Certificates	CE, UL/CSA, EAC

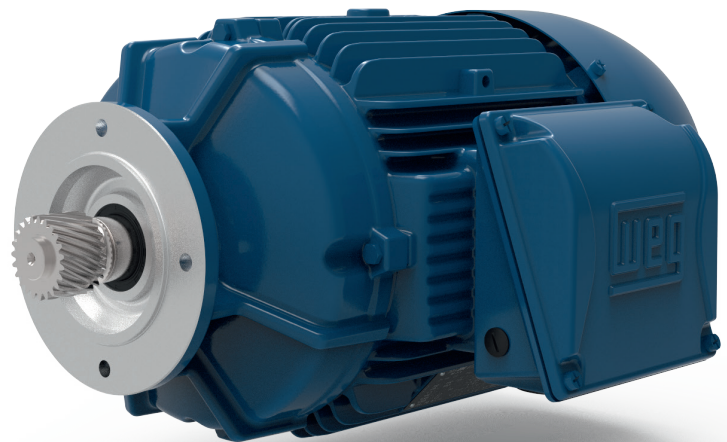

Motor modules for aluminium and cast iron motors

The particular advantage of the modular motor range is the facility to add system kits to the standard model, allowing a multitude of useful modules to be adapted to the customer's requirements.

Available motor modules include single and double brake systems, ventilation systems, extended terminal box systems, encoder systems (inside and outside the fan cover), back stops, protection caps, and hand wheel.

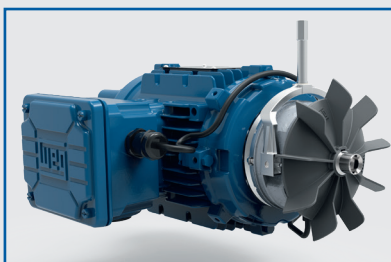

Spring loaded brake

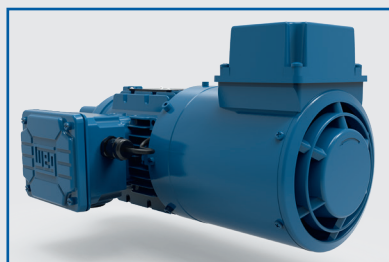

Forced ventilation

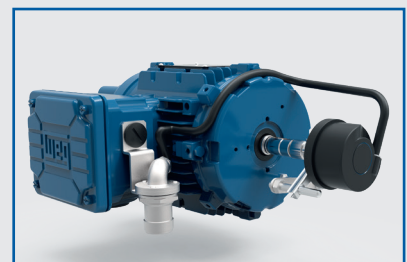

Incremental encoder (forced ventilation)





www.cat4cad.com

Easy product selection

The “cat4CAD®” product configuration tool makes it easy to interactively select products. Comprehensive wizards, user-friendly navigation and many other extra features allow quick configuration of the required drive.

Advantages

- Extensive product library
- Fast configuration of motors and geared motors
- Creation of project files with comprehensive technical documentation
- Easy modification of generated product data by means of the project file
- Quick request times

Features

- The entire menu is available in many languages.
- To-scale 2D/3D drawings and PDF and DXF dimension sheet drawings of the previously selected drive.
- The 2D/3D data can be exported for use in standard CAD programs.
- Comprehensive technical data sheets of the configured gearbox and motor at the click of a button.
- The project file allows complete management of previously selected drives on one screen.
At the click of a button one can save or print a project file, create PDF and DXF dimension drawings, and send inquiries directly to our sales team.

See the online version at www.cat4cad.com

Download the offline version at www.wattdrive.com



Advantages for you



A geared motor **for the whole world**

- Standard mounting dimensions
- Can be switched to different voltages around the world
- Certifications for international markets



Sophisticated design **for more efficiency**

- Wide speed range
- High efficiency
- Low noise levels
- Optimized oil fill quantity
- Maintenance-free and lubricated for life up to 5300 lb-in
- High quality components and equipment
- Motors to efficiency class IE4



Comprehensive equipment **for more flexibility**

- Can be extended by different motor modules
- Temperature monitoring without added costs
- Protection degree IP55 for the standard design
- Switchover to 100/120 Hz characteristic in frequency inverter operation



The optimal program **for lower costs**

- Reduction in operating costs for plant operators
- Standard mounting dimensions enable easy interchangeability without system conversion
- Low maintenance costs
- Flexibility and savings for purchasing, technology and warehousing



One company **for more service**

- Complete drive applications from WEG
- Global WEG branches and sales partners
- Short delivery times
- Innovative product configuration tool



WEG Electric Corp. offers the following products, and more! With a full range of IEC/NEMA Global Certifications and a full line of products, WEG can supply the right solution for your needs anywhere in the world. To learn more about WEG's products and solutions or to locate a Distributor near you, please call **1-800-ASK-4WEG** or visit **www.weg.net**.

**Low Voltage Motors,
Single and 3-Phase, 1/8 – 700HP**

- General Purpose Motors
- Explosion Proof Motors
- Crusher Duty Motors
- IEC Tru-Metric Motors
- Pump Motors including JP/JM
- P-Base Pump Motors
- Oil Well Pumping Motors
- Pool & Spa Motors
- Brake Motors
- Compressor Duty Motors
- Farm Duty Motors
- Poultry Fan Motors
- Auger Drive Motors
- IEEE 841 Motors
- Stainless Steel Wash Down Motors
- Saw Arbor Motors
- Cooling Tower Motors
- Commercial HVAC Motors
- Pad Mounted Motors
- Vector Duty Motors

Large Electric Motors

- Low Voltage 3-phase motors up to 2,500HP
- Induction Motors up to 70,000HP and 13,200V
- Wound Rotor Systems (including starters) up to 70,000HP and 13,200V
- Synchronous Motors up to 200,000HP and 13,200V
- Explosion proof motors (Ex-d) up to 1,500kW and 11kV
- Ex-n, Ex-e, Ex-p motors

Variable Frequency Drives

- Low Voltage 1/4 to 2500HP, 230V – 480V
- Medium Voltage 500-10,000HP
- Multi-pump systems
- NEMA 4X
- Dynamic braking resistors
- Line and load reactors
- Plug and play technology
- Network communications: Profibus-DP, DeviceNet, Modbus-RTU
- PLC functions integrated
- Complete line of options and accessories

Soft Starters

- 3-1500HP
- Oriented start-up
- Built-in bypass contactor
- Universal source voltage (230-575V, 50/60Hz)
- Network communications: Profibus-DP, DeviceNet, Modbus-RTU
- Complete Line of options and accessories
- MV Soft-starter 3.3kV, 4.16kV: up to 3500HP, Withdrawable Power Stacks, & 8x PT100 Temperature monitoring

Controls

- Mini – Contactors
- IEC Contactors
- Thermal Overload Relays
- Manual Motor Protectors
- Molded Case Circuit Breakers
- Smart Relays
- Enclosed Starters: combination & non-combination
- Pushbuttons & Pilot Lights
- Timing & Motor Protection Relays
- Terminal Blocks

Custom Panels

- Custom configured to your specification.
- NEMA 1, 12, 3R, 4 and 4X cabinets
- Quick delivery of preconfigured drives and soft starters
- UL 508 certified
- Low Voltage (230-460)
- Made in the U.S.A.

Generators

- Brushless Synchronous Generators for diesel gen-sets up to 4,200kVA
- Hydro-generators up to 25,000kVA
- Turbo-generators up to 175,000kVA

Power Transformers

- Built and engineered in North America
- Voltages < 345kV
- Ratings 5-250MVA
- Station class, oil filled, round core, copper windings
- Special configurations and designs available!
- Ask your WEG Sales Representative for details.
- Designed, built, and engineered to ANSI standards.

Custom Solution Package Sales

- WEG can package any of its products for ease of sale! Enjoy a single point of contact for the entire package of products and assistance from quote through after-sales support. Ask your WEG Sales Representative for details.



WEG ELECTRIC CORP.
 6655 Sugarloaf Parkway
 Duluth, GA 30097
 Phone: 1-800-ASK-4WEG
 Fax: 678-249-1155
info-us@weg.net
www.weg.net

Please contact your authorized distributor: